

USB-204-OEM

Analog and Digital I/O

User's Guide

Trademark and Copyright Information

Measurement Computing Corporation, InstaCal, Universal Library, and the Measurement Computing logo are either trademarks or registered trademarks of Measurement Computing Corporation. Refer to the Copyrights & Trademarks section on mccdaq.com/legal for more information about Measurement Computing trademarks. Other product and company names mentioned herein are trademarks or trade names of their respective companies.

© 2014 Measurement Computing Corporation. All rights reserved. No part of this publication may be reproduced, stored in a retrieval system, or transmitted, in any form by any means, electronic, mechanical, by photocopying, recording, or otherwise without the prior written permission of Measurement Computing Corporation.

Notice

Measurement Computing Corporation does not authorize any Measurement Computing Corporation product for use in life support systems and/or devices without prior written consent from Measurement Computing Corporation. Life support devices/systems are devices or systems that, a) are intended for surgical implantation into the body, or b) support or sustain life and whose failure to perform can be reasonably expected to result in injury. Measurement Computing Corporation products are not designed with the components required, and are not subject to the testing required to ensure a level of reliability suitable for the treatment and diagnosis of people.

Table of Contents

Preface

About this User's Guide	5
What you will learn from this user's guide	5
Conventions in this user's guide	5
Where to find more information	5

Chapter 1

Introducing the USB-204-OEM.....	6
Functional block diagram	6

Chapter 2

Installing the USB-204-OEM.....	7
Unpacking.....	7
Downloading the software.....	7
Installing the hardware	7
Installing on a Windows platform.....	7
Installing on an Android platform.....	7
Calibrating the hardware.....	7

Chapter 3

Functional Details	8
Analog input acquisition modes	8
Software paced mode.....	8
Hardware paced mode.....	8
Board components	9
Connector W1	9
Connector W3	10
Screw terminal connectors.....	10
USB connector.....	10
LED indicators.....	10
Signal connections.....	10
Analog input	10
External pacer I/O.....	10
Digital I/O.....	11
Trigger input.....	11
Counter input	11
Voltage output	11
Ground.....	11
Mechanical drawing	12

Chapter 4

Specifications.....	13
Analog input	13
Accuracy.....	13
Analog input DC voltage measurement accuracy	13
Noise performance.....	14
Analog input calibration	14
Digital input/output.....	14
External digital trigger.....	15
External pacer input/output.....	15
Counter	16
Memory	16
Power.....	16

USB specifications	17
Environmental	17
Mechanical	17
Header connectors	17
Screw terminal connector (not populated).....	18

About this User's Guide

What you will learn from this user's guide

This user's guide describes the Measurement Computing USB-204-OEM data acquisition device and lists device specifications.

Conventions in this user's guide

For more information

Text presented in a box signifies additional information related to the subject matter.

Caution! Shaded caution statements present information to help you avoid injuring yourself and others, damaging your hardware, or losing your data.

bold text **Bold** text is used for the names of objects on a screen, such as buttons, text boxes, and check boxes.

italic text *Italic* text is used for the names of manuals and help topic titles, and to emphasize a word or phrase.

Where to find more information

Additional information about USB-204-OEM hardware is available on our website at www.mccdaq.com. You can also contact Measurement Computing Corporation with specific questions.

- Knowledgebase: kb.mccdaq.com
- Tech support form: www.mccdaq.com/support/support_form.aspx
- Email: techsupport@mccdaq.com
- Phone: 508-946-5100 and follow the instructions for reaching Tech Support
-

For international customers, contact your local distributor. Refer to the International Distributors section on our website at www.mccdaq.com/International.

Introducing the USB-204-OEM

The USB-204-OEM is a USB 2.0 full-speed device that provides the following features:

- Eight single-ended 12-bit analog inputs
- 500 kS/s max sample rate
- Eight individually configurable digital I/O channels
- 32-bit counter input
- Digital trigger input
- External pacer clock input
- External pacer clock output
- User voltage output
- Two header connectors for field wiring connections

The USB-204-OEM device is compatible with both USB 1.1 and USB 2.0 ports. The speed of the device may be limited when using a USB 1.1 port due to the difference in transfer rates on the USB 1.1 versions of the protocol (low-speed and full-speed).

The USB-204-OEM is powered by the +5 V USB supply from your computer; no external power is required.

Caution! There are no product safety, electromagnetic compatibility (EMC), or CE marking compliance claims made for the USB-204-OEM. The USB-204-OEM is intended for use as a component of a larger system. MCC can help developers meet their compliance requirements. The end product supplier, however, is responsible for conforming to any and all compliance requirements.

Functional block diagram

Device functions are illustrated in the block diagram shown here.

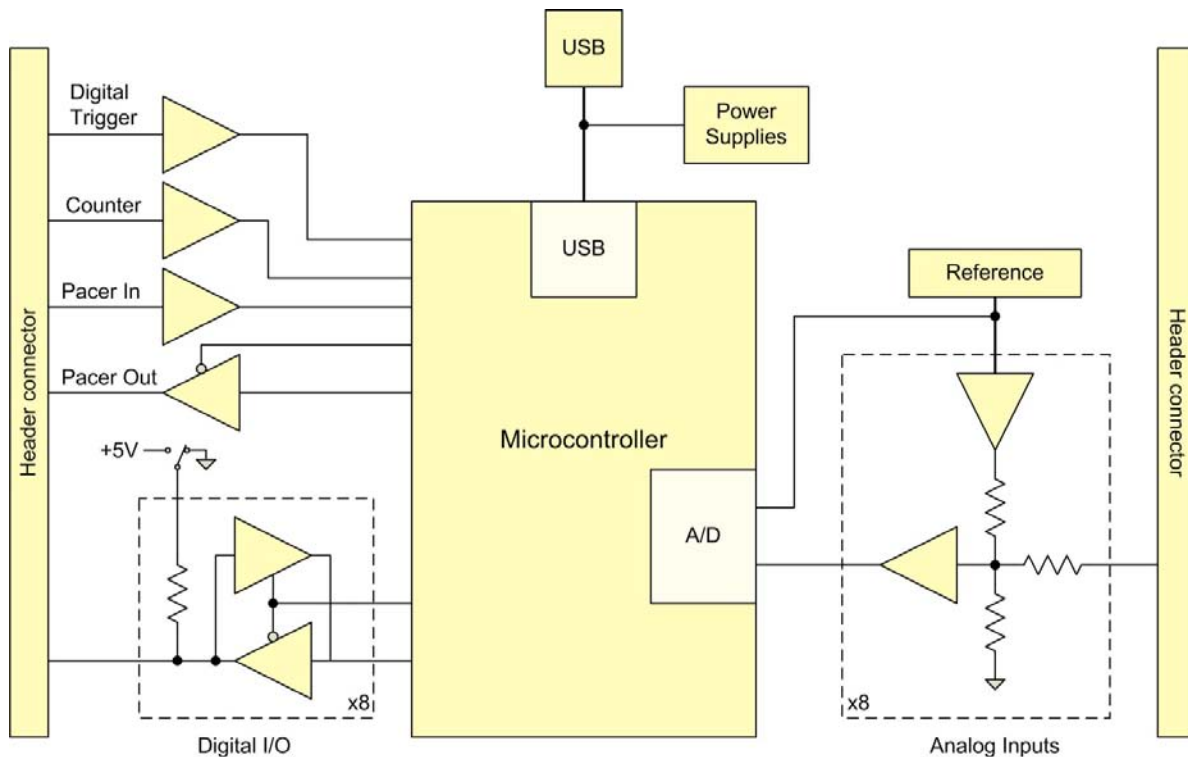

Figure 1. USB-204-OEM functional block diagram

Installing the USB-204-OEM

Unpacking

As with any electronic device, you should take care while handling to avoid damage from static electricity. Before removing the board from its packaging, ground yourself using a wrist strap or by simply touching the computer chassis or other grounded object to eliminate any stored static charge.

Downloading the software

Refer to the USB-204-OEM product page on the Measurement Computing website for information about the supported software you can download.

Install the software before you install the hardware

The driver needed to run the device is installed when you install the software. Therefore, you need to install the software package you plan to use before you install the hardware.

Installing the hardware

Installing on a Windows platform

Install the software before you install your device

A driver needed to run the USB-204-OEM is installed when you install the software. Therefore, you need to install the software package you plan to use before you install the hardware.

For operation on a Windows operating system, we recommend that you run Windows Update to update your operating system with the latest USB drivers.

To connect the USB-204-OEM to your system, turn on your computer and connect the USB cable to an available USB port on the computer or to an external USB hub connected to the computer. Connect the other end of the USB cable to the USB connector on the device. No external power is required.

When you connect the device for the first time to a computer running Windows, a **Found New Hardware** dialog opens when the operating system detects the device. The dialog closes after the device is installed.

A green **Status** LED indicates the device status. When the LED is on, the device is powered and ready for operation. When the LED is off, the device is not powered or did not initialize. Figure 2 on page 9 shows the location of the **Status** LED.

Installing on an Android platform

Many Android devices include a standard A-type USB port to connect to the USB-204-OEM. If your device does not have a USB port, you may need a USB OTG cable in order for your Android device to host a USB device. Refer to your Android device documentation for more information.

Calibrating the hardware

The Measurement Computing Manufacturing Test department performs the initial factory calibration. Return the device to Measurement Computing Corporation when calibration is required. The recommended calibration interval is one year.

Field calibration is not supported.

Functional Details

Analog input acquisition modes

The USB-204-OEM can acquire analog input data in two different modes – software paced and hardware paced.

Software paced mode

You can acquire one analog sample at a time in software paced mode. You initiate the A/D conversion with a software command. The analog value is converted to digital and returned to the computer. You can repeat this procedure until you have the total number of samples that you want.

The maximum throughput sample rate in software paced mode is system-dependent.

Hardware paced mode

You can acquire data from up to eight channels in hardware paced mode. The analog data is continuously acquired and converted to digital values until you stop the scan. Data is transferred in blocks of 32 samples from the device to the memory buffer on your computer.

The maximum continuous scan rate is an aggregate rate. The total acquisition rate for all channels cannot exceed 500 kS/s. The following table lists the scan rate when scanning from one to eight channels.

Maximum continuous scan rate

# channels scanned	Scan rate (kS/s)
1	500
2	250
3	166.67
4	125
5	100
6	83.33
7	71.43
8	62.50

You can start a hardware paced continuous scan with either a software command or with an external hardware trigger event.

Board components

Board components are shown in Figure 2. Note that each screw terminal location is unpopulated.

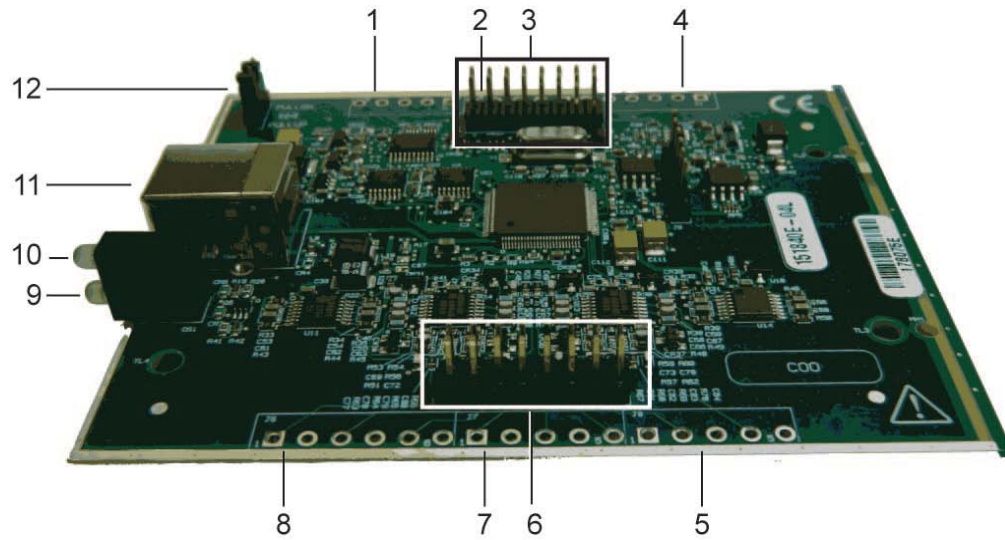

- | | | | | | |
|---|---------------------|---|---------------------|----|---------------------|
| 1 | Screw terminal J1 | 5 | Screw terminal J8 | 9 | Activity LED |
| 2 | Screw terminal J2 | 6 | Header connector W3 | 10 | Status LED |
| 3 | Header connector W1 | 7 | Screw terminal J7 | 11 | USB connector |
| 4 | Screw terminal J3 | 8 | Screw terminal J6 | 12 | Pull-up/down jumper |

Figure 2. Board components

Connector W1

Header connector W1 provides connections for the DIO, external clock I/O, trigger, counter, power output, and digital ground reference.

W1 pinout

Pin	Signal name	Pin description	Pin	Signal name	Pin description
1	DIO0	DIO channel 0	2	DIO1	DIO channel 1
3	DIO2	DIO channel 2	4	DIO3	DIO channel 3
5	DIO4	DIO channel 4	6	DIO5	DIO channel 5
7	DIO6	DIO channel 6	8	DIO7	DIO channel 7
9	GND	Digital ground	10	+VO	User voltage output
11	GND	Digital ground	12	AICKO	External clock pacer output
13	AICKI	External clock pacer input	14	CTR	Counter input
15	TRIG	Digital trigger input	16	GND	Digital ground

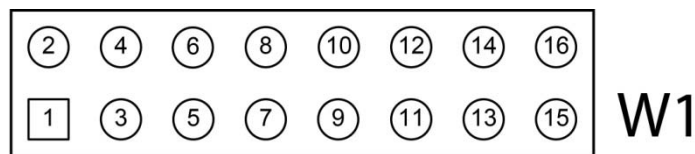

Figure 3. Connector W1 pinout

Connector W3

Header connector W3 provides connections for the analog inputs and the analog ground reference.

W3 pinout

Pin	Signal name	Pin description	Pin	Signal name	Pin description
1	CH0	Channel 0	2	AGND	Analog ground
3	CH1	Channel 1	4	AGND	Analog ground
5	CH2	Channel 2	6	AGND	Analog ground
7	CH3	Channel 3	8	AGND	Analog ground
9	CH4	Channel 4	10	AGND	Analog ground
11	CH5	Channel 5	12	AGND	Analog ground
13	CH6	Channel 6	14	AGND	Analog ground
15	CH7	Channel 7	16	AGND	Analog ground

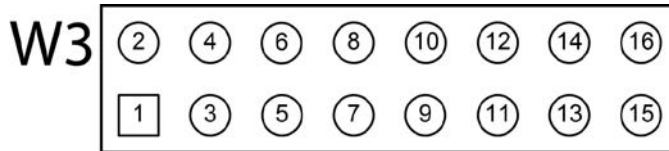

Figure 4. Connector W3 pinout

Screw terminal connectors

Screw terminals J1 through J8 are unpopulated. When populated the screw terminals provide alternative connections to the header connectors. Refer to the Specifications chapter for screw terminal pinouts.

USB connector

The USB connector provides +5 V power and communication. No external power supply is required.

LED indicators

The device has two LED indicators – **Status** and **Activity**.

- The **Status** LED turns on when the device is detected and installed on the computer.
- The **Activity** LED blinks when data is transferred, and is off otherwise.

Refer to Figure 2 on page 9 for the location of each LED.

Signal connections

Analog input

You can connect up to 8 single-ended inputs to screw terminals **CH0** to **CH7**. The input voltage range is ± 10 V. Single-ended mode requires two wires; connect one wire to the signal you want to measure (**CHx**), and connect a second wire to the analog ground reference (**AGND**).

External pacer I/O

The USB-204-OEM provides one external clock input (**AICKI**) and one clock output (**AICKO**) for the analog input pacer. You can connect an external clock signal to **AICKI**. When using the internal clock, **AICKO** outputs the ADC sample clock.

Digital I/O

You can connect up to eight digital I/O lines to **DIO0** through **DIO7**. The digital I/O terminals can detect the state of any TTL-level input. Refer to the schematic shown in Figure 5.

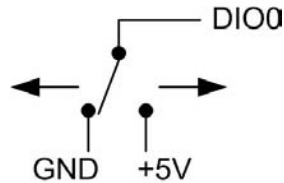

Figure 5. Schematic showing switch detection by digital channel DIO0

If you set the switch to the +5 V input, DIO0 reads *TRUE* (1). If you move the switch to GND, DIO0 reads *FALSE* (0).

Internal pull-up/down configuration

The digital port has 47 k Ω resistors that you can configure as pull-up or pull-down with an internal jumper. Unconnected inputs are pulled low by default to 0 V through 47 k Ω resistors. The pull-up/pull-down voltage is common to all 47 k Ω resistors.

You can change the configuration with an internal jumper; see Figure 2 on page 9 for the location this jumper.

Caution! The discharge of static electricity can damage some electronic components. Before handling the board, either ground yourself using a wrist strap or touch the computer chassis or other grounded object to eliminate any stored static charge.

Figure 6 shows the jumper configured for pull-down.

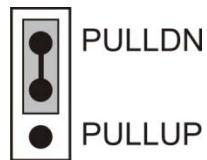

Figure 6. Pull-down jumper

Configure the jumper for pull-up to pull the digital inputs high (+5V).

Trigger input

The **TRIG** terminal is an external digital trigger input. The trigger mode is software-selectable for edge- or level-sensitive. The trigger is automatically re-armed after it is activated.

Counter input

The **CTR** terminal is a 32-bit event counter that can accept frequency inputs up to 1 MHz. The internal counter increments when the TTL levels transition from low to high.

Voltage output

The user voltage output (**+VO**) terminal can output up to 100 mA maximum at approximately +5V. You can use this terminal to supply power to external devices or circuitry.

Caution! The **+VO** terminal is an output. Do not connect to an external power supply or you may damage the device and possibly the computer.

Ground

The analog ground (**AGND**) terminals provide a common ground for all analog channels. The digital ground (**GND**) terminals provide a common ground for the digital, counter, pacer I/O, and power terminal.

For more information about signal connections

For more information about analog and digital signal connections, refer to the *Guide to DAQ Signal Connections* at www.mccdaq.com/pdfs/DAQ-Signal-Connections.pdf.

Mechanical drawing

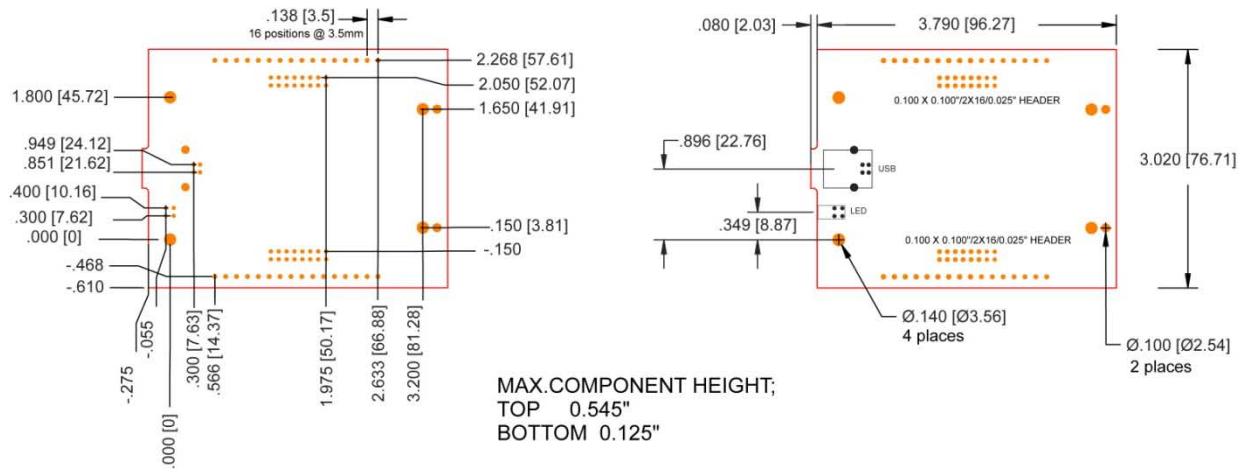

Figure 7. Circuit board dimensions

Specifications

All specifications are subject to change without notice.

Typical for 25 °C unless otherwise specified.

Specifications in *italic text* are guaranteed by design.

Analog input

Table 1. General analog input specifications

Parameter	Conditions	Specification
A/D converter type		Successive approximation
ADC resolution		12 bits
Number of channels		8 single-ended
Input voltage range		± 10 V
<i>Absolute maximum input voltage</i>	<i>CHx relative to AGND</i>	<ul style="list-style-type: none"> ■ ± 25 V max (power on) ■ ± 25 V max (power off)
<i>Input impedance</i>		<ul style="list-style-type: none"> ■ 1 MΩ (power on) ■ 1 MΩ (power off)
<i>Input bias current</i>	<i>10 V input</i>	-12 μ A
	<i>0 V input</i>	2 μ A
	<i>-10 V input</i>	12 μ A
Input bandwidth	Small signal (-3 dB)	1.0 MHz
Maximum working voltage	Input range relative to AGND	± 10.1 V max
Crosstalk	Adjacent channels, DC to 10 kHz	-75 dB
Input coupling		DC
Sampling rate	Internal pacer	0.016 S/s to 500 kS/s, software-selectable
	External pacer	500 kS/s max
Sample clock source		<ul style="list-style-type: none"> ■ Internal A/D clock ■ Pacer input terminal AICKI
Channel queue		Up to eight unique, ascending channels
Throughput	Software paced	33 to 4000 S/s typ, system dependent
	Hardware paced	500 kS/s max, system dependent
Warm-up time		15 minutes min

Accuracy

Analog input DC voltage measurement accuracy

Table 2. DC Accuracy components and specifications. All values are (\pm)

Range	Gain error (% of reading)	Offset error (mV)	Absolute accuracy at Full Scale (mV)	Gain temperature coefficient (% reading/°C)	Offset temperature coefficient (mV/°C)
± 10 V	0.098	11	20.8	0.016	0.87

Noise performance

For the peak to peak noise distribution test, the input channel is connected to AGND at the input terminal block, and 12,000 samples are acquired at the maximum throughput.

Table 3. Noise performance specifications

Range	Counts	LSBrms
±10 V	5	0.76

Analog input calibration

Table 4. Analog input calibration specifications

Parameter	Specification
Recommended warm-up time	15 minutes min
Calibration method	Factory
Calibration interval	1 year

Digital input/output

Table 5. Digital input specifications

Parameter	Specification
Digital type	TTL
Number of I/O	8
Configuration	Each bit may be configured as input (power on default) or output
Pull-up configuration	The port has 47 kΩ resistors that may be configured as pull-up or pull-down with an internal jumper. The factory configuration is pull-down.
Digital I/O transfer rate (system-paced)	33 to 4000 port reads/writes per second typical, system dependent
Input low voltage threshold	0.8 V max
Input high voltage threshold	2.0 V min
Input voltage limits	5.5 V absolute max -0.5 V absolute min 0 V recommended min
Output high voltage	4.4 V min (IOH = -50 μA) 3.76 V min (IOH = -24 mA)
Output low voltage	0.1 V max (IOL = 50 μA) 0.44 V max (IOL = 24 mA)
Output current	±24 mA max

External digital trigger

Table 6. External digital trigger specifications

Parameter	Specification
Trigger source	TRIG input
Trigger mode	Software configurable for edge or level sensitive, rising or falling edge, high or low level. Power on default is edge sensitive, rising edge.
Trigger latency	1 μ s + 1 pacer clock cycle max
Trigger pulse width	125 ns min
Input type	Schmitt trigger, 47 k Ω pull-down to ground
Schmitt trigger hysteresis	1.01 V typ 0.6 V min 1.5 V max
Input high voltage threshold	2.43 V typ 1.9 V min 3.1 V max
Input low voltage threshold	1.42 V typ 1.0 V min 2.0 V max
Input voltage limits	5.5 V absolute max -0.5 V absolute min 0 V recommended min

External pacer input/output

Table 7. External pacer I/O specifications

Parameter	Specification
Terminal names	AICKI, AICKO
Terminal types	AICKI: Input, active on rising edge AICKO: Output, power on default is 0 V, active on rising edge
Terminal descriptions	AICKI: Receives pacer clock from external source AICKO: Outputs internal pacer clock
Input clock rate	500 kHz max
Clock pulse width	AICKI: 400 ns min AICKO: 400 ns min
Input type	Schmitt trigger, 47 k Ω pull-down to ground
Schmitt trigger hysteresis	1.01 V typ 0.6 V min 1.5 V max
Input high voltage threshold	2.43 V typ 1.9 V min 3.1 V max
Input low voltage threshold	1.42 V typ 1.0 V min 2.0 V max
Input voltage limits	5.5 V absolute max -0.5 V absolute min 0 V recommended min
Output high voltage	4.4 V min (IOH = -50 μ A) 3.80 V min (IOH = -8 mA)
Output low voltage	0.1 V max (IOL = 50 μ A) 0.44 V max (IOL = 8 mA)
Output current	\pm 8 mA max

Counter

Table 8. CTR specifications

Parameter	Specification
Pin name	CTR
Number of channels	1 channel
Resolution	32-bit
Counter type	Event counter
Input type	Schmitt trigger, 47 k Ω pull-down to ground
Counter read/write rates (software paced)	33 to 4,000 reads/writes per second typ, system dependent
Schmitt trigger hysteresis	1.01 V typ 0.6 V min 1.5 V max
Input high voltage threshold	2.43 V typ 1.9 V min 3.1 V max
Input low voltage threshold	1.42 V typ 1.0 V min 2.0 V max
Input voltage limits	5.5 V absolute max -0.5 V absolute min 0 V recommended min
Input frequency	1 MHz max
High pulse width	25 ns min
Low pulse width	25 ns min

Memory

Table 9. Memory specifications

Parameter	Specification
Data FIFO	12 K (12,288) analog input samples
Non-volatile memory	2 KB (768 B calibration storage, 256 B UL user data, 1 KB DAQFlex user data)

Power

Table 10. Power specifications

Parameter	Conditions	Specification
Supply current	Typical (Note 1)	150 mA
	Maximum (including user voltage, DIO and AICKO loading)	500 mA
User voltage output terminal (+VO)		4.25 V min, 5.25 V max
User voltage output current		100 mA max

Note 1: This is the total quiescent current requirement for the device which includes up to 10 mA for the Status LED. This value does not include any potential loading of the digital I/O bits, AICKO, or user voltage.

USB specifications

Table 11. USB specifications

Parameter	Specification
USB device type	USB 2.0 (full-speed)
Device compatibility	USB 1.1, USB 2.0
USB cable type	A-B cable, UL type AWM 2725 or equivalent. (minimum 24 AWG VBUS/GND, minimum 28 AWG D+/D-)
USB cable length	3 m (9.84 ft) max

Environmental

Table 12. Environmental specifications

Parameter	Specification
Operating temperature range	0 °C to 55 °C max
Storage temperature range	-40 °C to 85 °C max
Humidity	0% to 90% non-condensing max

Mechanical

Table 13. Mechanical specifications

Parameter	Specification
Dimensions (L × W × H)	98.30 × 76.71 × 14.61 mm (3.87 × 3.02 × 0.575 in.) max

Header connectors

Table 14. Header connector specifications

Parameter	Specification
Connector type	Two 2 × 8 0.1 in. pitch headers, labeled W1 and W3

Table 15. W1 pinout

Pin	Signal name	Pin description	Pin	Signal name	Pin description
1	DIO0	DIO channel 0	2	DIO1	DIO channel 1
3	DIO2	DIO channel 2	4	DIO3	DIO channel 3
5	DIO4	DIO channel 4	6	DIO5	DIO channel 5
7	DIO6	DIO channel 6	8	DIO7	DIO channel 7
9	GND	Digital ground	10	+VO	User voltage output
11	GND	Digital ground	12	AICKO	External clock pacer output
13	AICKI	External clock pacer input	14	CTR	Counter input
15	TRIG	Digital trigger input	16	GND	Digital ground

Table 16. W3 pinout

Pin	Signal name	Pin description	Pin	Signal name	Pin description
1	CH0	Channel 0	2	AGND	Analog ground
3	CH1	Channel 1	4	AGND	Analog ground
5	CH2	Channel 2	6	AGND	Analog ground
7	CH3	Channel 3	8	AGND	Analog ground
9	CH4	Channel 4	10	AGND	Analog ground
11	CH5	Channel 5	12	AGND	Analog ground
13	CH6	Channel 6	14	AGND	Analog ground
15	CH7	Channel 7	16	AGND	Analog ground

Screw terminal connector (not populated)

Table 17. Screw terminal connector specifications

Parameter	Specification
Connector type	3.51mm screw terminal footprints (not populated), labeled J1, J2, J3, J6, J7, J8

Table 18. Screw terminal pinout

J1			J6		
Pin	Signal name	Pin description	Pin	Signal name	Pin description
5	DIO0	DIO channel 0	1	CH0	Channel 0
4	DIO1	DIO channel 1	2	AGND	Analog ground
3	DIO2	DIO channel 2	3	CH1	Channel 1
2	DIO3	DIO channel 3	4	AGND	Analog ground
1	DIO4	DIO channel 4	5	CH2	Channel 2
			6	AGND	Analog ground
J2			J7		
Pin	Signal name	Pin description	Pin	Signal name	Pin description
5	DIO5	DIO channel 5	1	CH3	Channel 3
4	DIO6	DIO channel 6	2	AGND	Analog ground
3	DIO7	DIO channel 7	3	CH4	Channel 4
2	GND	Digital ground	4	AGND	Analog ground
1	+VO	User voltage output	5	CH5	Channel 5
J3			J8		
Pin	Signal name	Pin description	Pin	Signal name	Pin description
6	GND	Digital ground	1	AGND	Analog ground
5	AICKO	External clock pacer output	2	CH6	Channel 6
4	AICKI	External clock pacer input	3	AGND	Analog ground
3	CTR	Counter input	4	CH7	Channel 7
2	TRIG	Digital trigger input	5	AGND	Analog ground
1	GND	Digital ground			

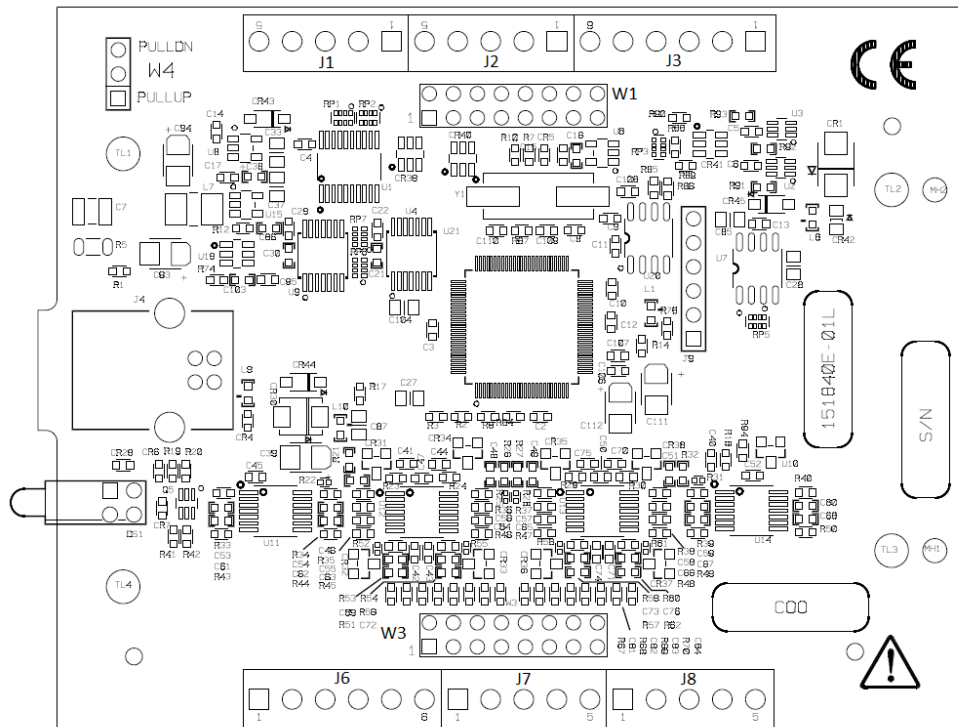

Measurement Computing Corporation
10 Commerce Way
Suite 1008
Norton, Massachusetts 02766
(508) 946-5100
Fax: (508) 946-9500
E-mail: info@mccdaq.com
www.mccdaq.com