

WebDAQ 316 User's Guide

May 2020. Rev 7



Contents

[About this User's Guide](#)

[Introducing the WebDAQ 316](#)

[Setting up the WebDAQ](#)

[Functional Details](#)

[Specifications](#)

[EU Declaration of Conformity](#)

Trademark and Copyright Information

Measurement Computing Corporation, InstaCal, Universal Library, and the Measurement Computing logo are either trademarks or registered trademarks of Measurement Computing Corporation. Refer to the Copyrights & Trademarks section on mccdaq.com/legal for more information about Measurement Computing trademarks. Other product and company names mentioned herein are trademarks or trade names of their respective companies.

© Measurement Computing Corporation. All rights reserved. No part of this publication may be reproduced, stored in a retrieval system, or transmitted, in any form by any means, electronic, mechanical, by photocopying, recording, or otherwise without the prior written permission of Measurement Computing Corporation.

Notice

Measurement Computing Corporation does not authorize any Measurement Computing Corporation product for use in life support systems and/or devices without prior written consent from Measurement Computing Corporation. Life support devices/systems are devices or systems that, a) are intended for surgical implantation into the body, or b) support or sustain life and whose failure to perform can be reasonably expected to result in injury. Measurement Computing Corporation products are not designed with the components required, and are not subject to the testing required to ensure a level of reliability suitable for the treatment and diagnosis of people.

About this User's Guide

This user's guide describes the Measurement Computing WebDAQ 316 data acquisition device, the WebDAQ web interface, and lists device specifications.

Where to find more information

Additional information about the WebDAQ Series of internet enabled data loggers is available on our website at www.mccdaq.com/WebDAQ. You can also contact Measurement Computing Corporation with specific questions.

- WebDAQ web interface: Open the **Help** window for information about using WebDAQ software.
- Knowledgebase: kb.mccdaq.com
- WiFi adapters approved for use with WebDAQ Series hardware: www.mccdaq.com/pdfs/manuals/wd-wifi.pdf
- Tech support form: www.mccdaq.com/support/support_form.aspx
- Email: techsupport@mccdaq.com
- Phone: 508-946-5100 and follow the instructions for reaching Tech Support

For international customers, contact your local distributor. Refer to the International Distributors section on our website at www.mccdaq.com/International.

Hazardous voltages

Take the following precautions if you connect hazardous voltages to the WebDAQ 316 spring terminals. A hazardous voltage is a voltage greater than 42.4 Vpk or 60 VDC to earth ground.

- Ensure that hazardous voltage wiring is performed only by qualified personnel adhering to local electrical standards.
- Do not mix hazardous voltage circuits and human-accessible circuits on the same device.
- Make sure that devices and circuits connected to the WebDAQ 316 are properly insulated from human contact.

When device terminals are hazardous voltage LIVE (>42.4Vpk/60 VDC), you must install the high voltage screw terminal backshell (ACC-401) to ensure that the terminals are not accessible and that the devices and circuits connected to the WebDAQ 316 are properly insulated from human contact.

Hazardous locations : The WebDAQ 316 is not certified for use in hazardous locations.

[Contents](#)

Introducing the WebDAQ 316

The WebDAQ 316 is part of the WebDAQ Series of Internet enabled data loggers. WebDAQ 316 is a thermocouple acquisition and logging device that provides the following features:

- 16 differential thermocouple inputs
- 75 S/s/ch sample rate
- 250 Vrms channel-to-earth isolation
- Overvoltage protection between any two inputs
- 50/60 Hz noise rejection
- Cold junction compensation (CJC)
- Auto zero channel
- Four bidirectional, isolated DIO that are individually configurable for input (trigger) or output (alarm)
- 10/100 Ethernet interface
- Support for USB WiFi adapters for wireless connectivity
- Support for USB mass storage devices and SD cards for data logging or file transfer
- Powered by an external power supply

WebDAQ Series devices are designed with an integrated operating system and web interface. You communicate with the device over a network connection using the web interface opened in a web browser.

- Mobile support – access the WebDAQ from any device with a web browser, such as a phone or tablet
- Remote monitoring and control
- Run simple to complex logging operations
- Flexible task scheduling

Powered by Raspberry Pi

The WebDAQ is designed with the Raspberry Pi Compute Module, featuring a quad core processor with speeds up to 1.2 GHz, 1GB RAM and 4 GB Flash memory.

Integrated operating system and web service

The WebDAQ is a complete data acquisition system containing an embedded operating system and web server. The operating system resides in internal flash memory, and includes a web service and device driver. All configuration, acquisition, and data management is performed using the web interface.

Ethernet interface

The WebDAQ has a built-in 10/100 BASE-T auto-negotiation, high-speed communication port. You can access and configure your WebDAQ from anywhere with access to the network to which it is connected. A unique MAC address is assigned to each device at the factory. You configure the Ethernet connection settings through a web interface. The default network name uses the format webdaq-xxxxxx, where xxxxxx are the lower six digits of the factory-assigned MAC address. You can change this name with the web interface.

Open-source software

WebDAQ firmware uses open-source software components. Refer to [Licenses](#) for the licensing information of each component. Open-source code is available upon request from info@mccdaq.com.

Unpacking

As with any electronic device, you should take care while handling to avoid damage from static electricity. Before removing the board from its packaging, ground yourself using a wrist strap or by simply touching the computer chassis or other grounded object to eliminate any stored static charge.

[Contents](#)

Setting up the WebDAQ

Connecting to a local area network

The WebDAQ requires a TCP/IP connection to a network or the Ethernet port of a computer. A standard Ethernet cable is shipped with the device. The WebDAQ IP address type is set by default for DHCP/Link-Local. When connected to a network, the device first attempts to receive an IP address from a DHCP server. If this fails, a link-local address is used. Use of a static address requires configuration via the web interface. The IP address identifies the WebDAQ on the network, and is used to access the web interface.

Connecting to a network with DHCP enabled

Connect one end of the Ethernet cable to the connector on the WebDAQ rear panel, and connect the other end to a 10Base-T or 100Base-TX compatible Ethernet port, hub, or switch.

Once the device is detected, DHCP assigns an address. A different address may be assigned each time the hardware is connected to the network.

WiFi support

After successfully configuring a wired connection, you can use the web interface to configure the WebDAQ for wireless communication. Refer to the [Configuring the WebDAQ for wireless communication](#) section for more information.

Connecting directly to a PC

Connect one end of the Ethernet cable to the connector on the WebDAQ rear panel, and connect the other end directly to the Ethernet port on a PC. The WebDAQ attempts to communicate with the host PC using 169.254.100.100 – the link-local address stored on the device. The host PC may accept this address or use a different address. The link-local address is valid only for communications between the WebDAQ and the host PC to which it is connected.

Connecting the external power adapter

Connect the network cable before connecting to external power

Connecting to the external supply before installing on a network results in the device attempting to auto-negotiate a network address before one is available.

Connect the adapter to the power connector labeled **EXT PWR** on the device rear panel, and plug the AC adapter into an electrical outlet.

Press the **POWER** button. The **POWER** LED on the rear panel turns yellow as the hardware starts up, and green when it is ready for use.

Detecting the device on a network

WebDAQ uses the "zeroconf" zero-configuration protocol to announce its presence on a local area network. Zeroconf uses a device name which can be accessed from other computers on the network.

Zero-configuration networking is helpful to find your WebDAQ hardware on the network

The easiest way to add zeroconf support to Windows is to install *Bonjour Print Services*. Bonjour software is Apple's implementation of zero-configuration networking, and is readily available as a free download – open a browser window and search for Bonjour Print Services. Zeroconf is built into popular applications such as Apple iTunes® and instant messaging software, so your computer may already support it. Many Linux systems will have the avahi version of zeroconf installed by default, so it's likely zeroconf is available if you're running Linux.

Accessing the WebDAQ web interface

To access the WebDAQ web interface, open a browser window and enter `http://webdaq-xxxxxx.local`, where xxxxxx is the last 6 digits of the MAC address. The MAC address is on a label at the bottom of the WebDAQ enclosure.

- If your network is configured for the zeroconf protocol, the WebDAQ web interface opens.
- If the web interface does not open or an error is returned, install a device discovery tool such as Bonjour Print Services. Refer to the note above about zero-configuration networking.

Browser support

The latest version of Chrome, Firefox, Safari, UC Browser, or Opera recommended. Compatible with the Edge browser version 79 and up. Not recommended for use with earlier versions of the Edge browser. Not recommended for use with Internet Explorer.

The WebDAQ web interface is shown here.

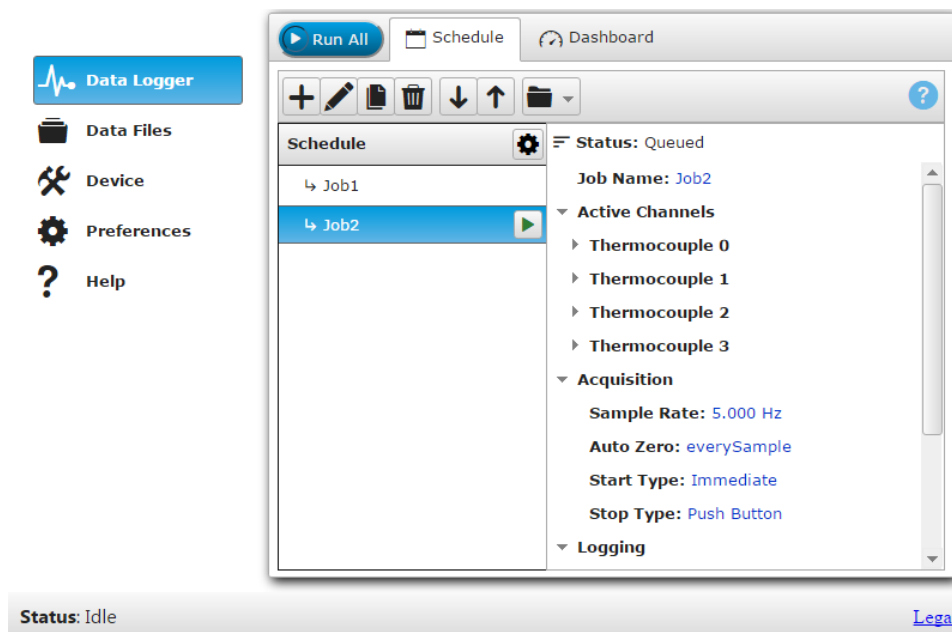

Figure 1. WebDAQ web interface

Use the WebDAQ web interface to configure hardware and acquisition options, schedule and run jobs, and to view and manage data. The Help window provides details about all components on the web interface. Once a connection is established and you can communicate to the device, you can change the configuration for other network scenarios.

Configuring the WebDAQ for wireless communication

Once communication is established on a wired network, you can connect a WiFi adapter to the USB port and use the web interface to configure the WebDAQ for communication over a wireless network. With the WebDAQ connected through the wired connection, perform the following procedure.

1. Connect an approved WiFi adapter to the USB port on the WebDAQ rear panel.
A list of WiFi adapters approved for use with WebDAQ Series hardware is available on our website at www.mccdaq.com/pdfs/manuals/wd-wifi.pdf.
2. Open the WebDAQ web interface in a browser window and go to the **Device** window, **Network** tab.
3. Select **WiFi**. Once the list of available networks updates, select the wireless network that you want to connect to, and enter the password, if any.
If the connection is successful, the selected wireless network will show above this list with a checkmark next to it.
You can click on the selected network to open a **WiFi Network Settings** dialog box where you can forget the current network or configure the IP address type (DHCP/Link-Local or Static).
4. Disconnect the Ethernet cable from the LAN connection.
Wait a few seconds, and refresh the browser window.

Changing to a wireless network may require a reboot

If a connection can't be established after changing the network, you may need to reboot the operating system and restart the WebDAQ using the **Power** button.

Configuring the network router for communication across networks

To communicate with the WebDAQ over the internet from a computer connected to a different network, you must change the network configuration of the network router.

Caution! This procedure should only be performed by a network administrator or computer professional. Incorrect settings can significantly disrupt a network.

In the following procedure, the WebDAQ is installed on the host LAN, the computer is installed on the client LAN, and it is assumed that you have successfully connected the device to a local network.

1. Determine the IP address of the WebDAQ – open the Device window from the web interface, and note the IP Address value on the Network Settings tab.
2. Configure your router so that the address determined above is a static address. The procedure for accomplishing this varies between routers; refer to your router documentation for instructions.
3. Configure the firewall/router to forward an unused port to port 80 on the WebDAQ at the IP address configured for the device.
Note the static IP address assigned to the router – this is referred to as the WAN address.
4. To access your WebDAQ from a remote location, enter the WAN address followed by the port selected above preceded by a colon in the web browser.
The format of the address entered in the browser is: 00.000.00.00:00000 (WAN address of router:port selected for the WebDAQ).

Security

Use the web interface to set the level of access to the website and to change the administrator password.

- High: access to the web page requires a password.
- Medium: access to the web page is permitted for any user, and data can be read by any user, but changes to the device configuration or files require a password.
- Off: full access is permitted for all users; no password is required.

By default, security access is set to "Off", and the administrator password is set to "admin".

To change the security level or password, open the web interface and go to the Device window, Security tab.

Use the device Reset button to restore security settings to factory default values.

Restoring factory default settings

To restore network configuration and security settings to the factory default values, use a paper clip to press the CONFIG RESET button. When pressed, the default network and security settings are written to the device and the WebDAQ is rebooted.

Factory default settings

Parameter	Specification
IP address	192.168.0.101
Subnet mask	255.255.255.0
Gateway	192.168.0.1
DHCP setting	DHCP + link-local enabled
Security level	Off
Password for the admin account	admin (case-sensitive)
Password for the share account	share (case-sensitive)
Device name	webdaq-xxxxxx, where xxxxxx is the last 6 digits of the MAC address (printed on the label on the underside of the device).

The network settings, security level, user account passwords and device name can be changed with the WebDAQ web interface.

Shared folders and mapped drives are reset when factory defaults are restored.

Contents

Functional Details

Functional block diagram

Device functions are illustrated in the block diagram shown here.

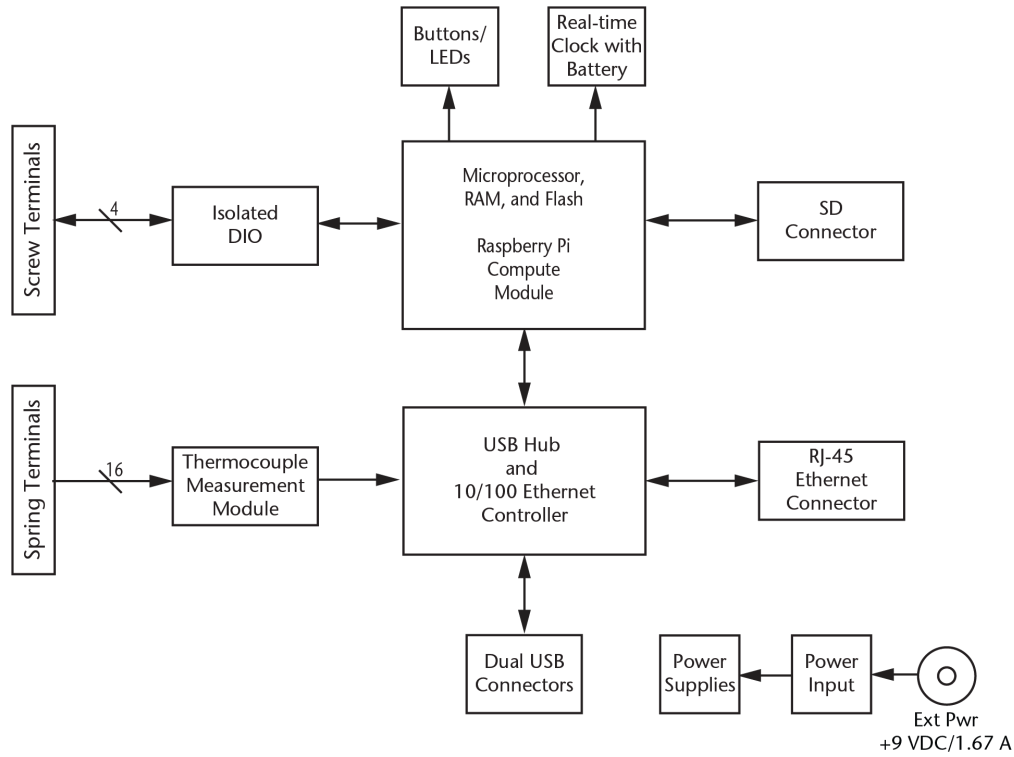

Figure 2. Functional block diagram

Front panel components

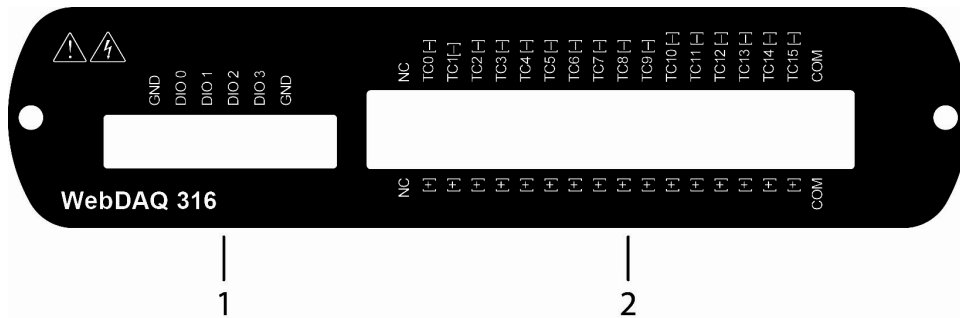

Figure 3. Front panel

1	Screw terminal	2	Spring terminal
---	----------------	---	-----------------

Screw terminal (Digital connections)

Connect up to four digital I/O lines (DIO0 to DIO3) to the detachable screw terminal.

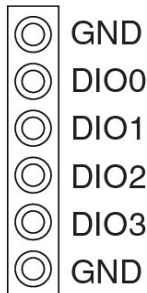

Figure 4. Screw terminal pinout

The digital ground (GND) terminals provide a common ground for the digital bits.

The digital I/O lines are electrically isolated from the analog circuits. Each bit is individually configurable for input or output, and features Schmitt trigger inputs and open drain outputs. All DIO channels are pulled high to 5 V.

Any digital bit can be configured with the web interface as a trigger to start or stop an acquisition, to trigger an alarm and be driven high or low when an alarm or occurs, or be driven high or low when an event condition occurs.

Spring terminal (Analog connections)

Connect up to 16 thermocouple or voltage inputs (TC0+/TC0– to TC15+/TC15–) and two common reference connections (COM) to the 36-position detachable spring terminal.

Caution! We strongly recommend that you ground yourself using a wrist strap before handling thermocouple sensors.

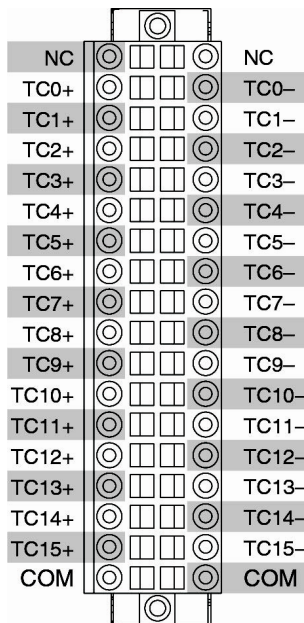

Figure 5. Spring terminal pinout

Thermocouple connections

A thermocouple consists of two dissimilar metals that are joined together at one end. When the junction of the metals is heated or cooled, a voltage is produced that correlates to temperature.

The WebDAQ 316 supports type J, K, S, R, B, E, T, N thermocouples (TC), and provides overvoltage protection between any two inputs. A typical thermocouple connection is shown in the following figure.

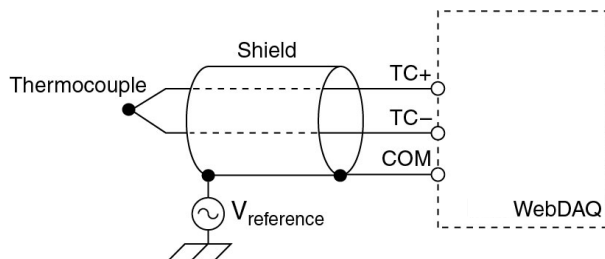

Figure 6. Typical thermocouple connection

Connect the shield to a common mode voltage reference on the thermocouple. A valid reference is voltage within ± 1.2 V of all the connected thermocouples.

Minimizing thermal gradients

Changes in the ambient air temperature near the thermocouple connectors or a thermocouple wire conducting heat directly to terminal junctions can cause thermal gradients. Observe the following guidelines to minimize thermal gradients and improve system accuracy:

- Use small-gauge thermocouple wire. Smaller wire transfers less heat to or from the terminal junction.
- Run thermocouple wiring together near the spring terminal connector to maintain a consistent temperature.
- Avoid running thermocouple wires near hot or cold objects.
- Minimize adjacent heat sources and air flow across the terminals.
- Keep the ambient temperature as stable as possible.

Increasing the thermocouple length

If you need to increase the length of your thermocouple, use the same type of TC wires to minimize the error introduced by thermal EMFs.

Analog input circuitry

Each channel passes through a differential filter and then is multiplexed and sampled by a 24-bit ADC. The channels share a common ground (COM) that is isolated from the digital subsystem.

The circuitry for one thermocouple channel is shown in here.

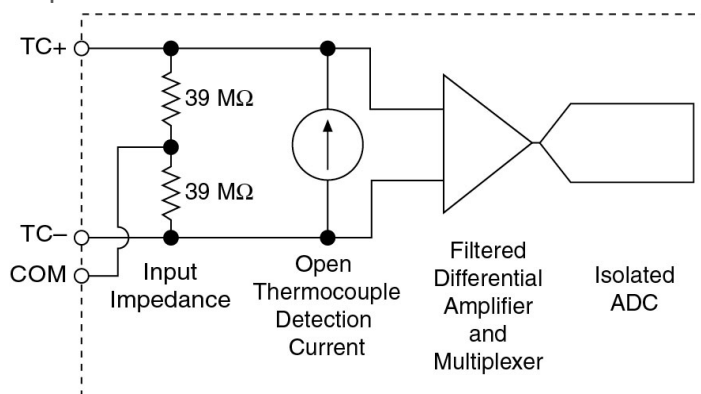

Figure 7. Input circuitry of one TC channel

Open thermocouple detection

Each channel has an open thermocouple detection (OTD) circuit which consists of a current source between the TC+ and TC- terminals. If an open thermocouple is connected to the channel, the current source forces a full-scale negative voltage across the terminals.

Input Impedance

Each channel has a resistor that produces an input impedance between the TC and COM terminals. The gain and offset errors resulting from the source impedance of connected thermocouples are negligible for most applications. Thermocouples with a longer lead length can introduce more significant errors.

Overvoltage protection

WebDAQ provides 30 V overvoltage protection between any two inputs.

Thermocouple measurement accuracy

Thermocouple measurement errors depend partly on the type and accuracy of the thermocouple, the temperature being measured, the resistance of the thermocouple wires, and the cold-junction temperature.

For increased accuracy, follow the guidelines in the [Minimizing thermal gradients](#) section, and use the auto zero channel to compensate for offset errors.

Cold-junction accuracy

Heat dissipated by nearby heat sources can cause errors in thermocouple measurements by heating the WebDAQ 316 terminals to a different temperature than the cold-junction compensation sensor. Thermal gradient across the terminals can cause the terminals of different thermocouple channels to be at different temperatures, which creates accuracy errors and affects the relative accuracy between channels.

The temperature measurement accuracy specifications include errors caused by the thermal gradient across the WebDAQ 316 terminals for configurations with the terminals facing forward or upward.

Auto zero channel

The WebDAQ 316 has an internal auto zero channel to compensate for offset errors. When enabled, the WebDAQ measures the autozero channel and subtracts that measurement from the measurement of each thermocouple channel. Use the web interface to enable auto zero. WebDAQ 316 specifications assume that auto zero is enabled and applied to every sample.

Rear panel components

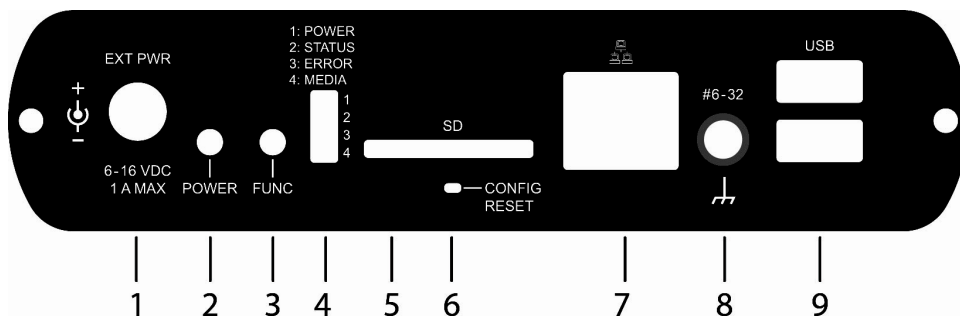

Figure 8. Rear panel

1	External power connector	4	LED indicators (4)	7	Ethernet connector
2	Power button	5	SD card slot	8	Ground connector
3	Function button	6	Factory reset button (recessed)	9	USB connectors (2)

External power connector

Connect the external AC adapter to the connector labeled **EXT PWR** on the rear panel. Click [here](#) to jump to the power specifications.

Power button

The button labeled **POWER** turns the WebDAQ device on and off. WebDAQ hardware is designed with a 2-pin jumper (W1) that users can remove to continuously power the device. The behavior of the POWER button when jumper W1 is installed or removed is listed in the following table.

Jumper W1 installed (factory default setting)	Jumper W1 removed
<ul style="list-style-type: none"> When the device is off, press the POWER button briefly to turn the device on. 	<ul style="list-style-type: none"> The device is always on as long as the power adapter is connected and receiving power (Power-On Mode).
<ul style="list-style-type: none"> When the device is on, press the POWER button for approximately 1 second to shut down the operating system and WebDAQ hardware; release the button when the POWER LED blinks yellow. The operating system automatically powers off the device at the end of the shutdown procedure. Press and hold the POWER button for approximately 4 seconds to force the device to power off. Any unsaved changes may be lost when powering down using this method. 	<ul style="list-style-type: none"> Press for approximately 1 second to reboot the device; release the button when the POWER LED blinks yellow.

Refer to [Power-On Mode](#) for the procedure to remove jumper W1 and enable Power-On mode.

The WebDAQ device can also be restarted or shut down using the web interface; refer to the WebDAQ help for details.

Function button

The button labeled **FUNC** has two functions; it can be used to eject external media or to start/stop an acquisition.

- Eject external media (default): Pressing the button unmounts all removable media so they can be safely removed from the device.
- Start or stop an acquisition (requires configuration with the web interface): When configured, pressing this button starts an acquisition, or stops an acquisition that is currently running.

Use the web interface to safely unmount removable media, when present.

When removable media is plugged into the WebDAQ, the operating system opens it for writing. To safely remove the media, you must unmount it first.

When a job is configured to log data to external media, pressing **FUNC** while the job is running will not eject the media.

The **MEDIA** LED is steady green when all media is unmounted and safe to remove, and off when all media is removed.

LED status indicators

The WebDAQ has four LEDs on the rear panel that indicate the status of power and host communications. The following table defines the LED states during normal operation.

LED states – normal operating mode

Label	State	Description
1: POWER	Steady yellow	Device is booting up
	Steady green	Device boot is successful.
	Blinking yellow	Device is shutting down.
	Off	Device is off.
2: STATUS	Blinking yellow	Device is configuring hardware.
	Steady green	Hardware configuration is complete.
	Flashing green 100 ms on/2s off)	Waiting for a scheduled start condition to be met.
	Blinking heartbeat	Scheduled start condition is met; waiting for job start condition to be met.
	Blinking green	Data is being acquired (job start condition is met).
	Off	No error detected.
3: ERROR	Blinking yellow	Error condition is detected. This LED blinks even when the software is configured to ignore the error. Error state is cleared when the next schedule starts.
	Off	No error detected.
4: MEDIA	Blinking yellow	A job is configured to log to external media, but the job hasn't started yet; pushbutton will not let you eject media.
	Steady yellow	External media is inserted into the SD card slot or USB storage port.
	Blinking green	Currently logging to an external SD card or USB storage device.
	Steady green	Media has been made safe for removal using the function button, but has not been removed.

WebDAQ LEDs behave differently when software is updated on the device. The following table defines the LED states during a software update.

LED states – software update mode

LED	State	Description
All LEDs	Solid yellow	Software update is starting
POWER	Blinking yellow	Software update is running
STATUS	Blinking green	Update file is located; device is being updated
	Blinking yellow	Update file cannot be located; insert media with update file
ERROR	Blinking green	Update is successful; device will reboot in approximately 5 seconds
	Blinking yellow	Update failed; user must retry

Refer to [Updating WebDAQ firmware](#) for more information about WebDAQ firmware.

SD card slot

The SD slot accepts SD (Secure Digital), SDHC, SDXC, MMC, and TransFlash memory cards. Memory cards can be ejected using the web interface or the hardware FUNC button, unless the button is configured to start/stop an acquisition.

When removable media is plugged into the WebDAQ, the operating system opens it for writing. Use the **FUNC** button or web interface to unmount the SD card before removing.

Factory reset button

The recessed button labeled **CONFIG RESET** restores factory default settings. When pressed, the default settings are written to the device and the WebDAQ is rebooted. Refer to the [Restore factory default settings](#) section for a list of the default settings that are restored.

Ethernet connector

The WebDAQ has one 10 Base-T/100 Base-TX, auto-negotiation, high-speed communication port. The port connector is an RJ-45, eight-position connector. The Ethernet port accepts shielded or unshielded twisted pair cable. The maximum communication distance without using a repeater is 100 m (328 ft). For CE compliance the maximum distance is 3 m (9.84 ft).

Ground connector

The WebDAQ ships with a ground screw in the connector labeled **#6-32**. To ground the WebDAQ chassis, attach a ring lug to a 14 AWG (1.6 mm) wire. Connect the ring lug to the grounding screw on the WebDAQ rear panel. Attach the other end to a safety ground.

USB connectors

The two high-speed USB ports can be used for connections to a mass storage device and approved WiFi adapter.

When removable media is plugged into the WebDAQ, the operating system opens it for writing. Use the **FUNC** button or web interface to unmount the USB device before removing.

Use a self-powered hub when external media requires higher current

USB-powered hard drives may use an excessive amount of current during operation. The WebDAQ device could shut down or experience other errors if the power requirements of a connected device exceed the power available. Use a self-powered hub if the current requirement of external media exceeds 500 mA.

We recommend that you connect USB-powered hard drives before powering up the WebDAQ.

Logging data

You can log up to 3 GB of data to internal WebDAQ storage. To generate larger data files, log data to external media with a storage capacity suitable for the acquisition. USB drives and SD cards are available in different file formats, and OS support for each format varies. WebDAQ supports FAT32, exFAT, ext2/3/4, NTFS file systems. When generating large data files with Windows or Mac, or transferring files between operating systems, we recommend using external media formatted with the exFAT file system, such as an SDXC memory card. When running Linux, use external media formatted with the ex2/ex3/ex4 file system. Refer to the WebDAQ help FAQ for more information about file formats.

File too large error

If you generate data that exceeds the capacity of the selected storage location, a "File too large" error is returned and the acquisition stops. To avoid interruptions, select a storage location with a large capacity.

Logging data to external media

Acquiring data at high speeds can generate large file sizes. If you expect to acquire a large amount of data to a *single file* when logging to external media, do not use media formatted with the FAT32 file system. FAT32 is limited to a 4 GB maximum file size. If the log file on FAT32 media grows beyond that size, a "File too large" error is returned and the acquisition stops. Before starting a logging session of this type, reformat the media using a different file system such as NTFS. Refer to the *Frequently Asked Questions* help topic for more information about file systems.

Power-On Mode

WebDAQ Series hardware can be configured to start automatically when power is applied, instead of requiring users to press the **POWER** button. This is useful if the WebDAQ is operating in a remote location and a power loss occurs. This "power-on mode" is enabled by removing a 2-pin jumper (labeled **W1**) from the WebDAQ circuit board.

When jumper W1 is removed, the device does not shutdown completely unless the power adapter is unplugged from the device or power source.

Perform the procedure below to remove jumper W1 from the WebDAQ circuit board and enable power-on mode.

Caution! The discharge of static electricity can damage some electronic components. Before removing the WebDAQ device from its housing, ground yourself using a wrist strap or touch the computer chassis or other grounded object to eliminate any stored static charge.

1. Power down the WebDAQ device and disconnect the power supply.

2. On the rear panel, remove the Ethernet cable, power cable, SD card, and any USB devices.
3. Remove the #6-32 ground screw.
4. Remove the nut and washer from the EXT PWR connector.
5. Remove the two front panel bezel screws and remove the front bezel.
6. Slide out the circuit board with the front panel intact.
7. Remove jumper W1 from the specified location shown below.

Jumper W1

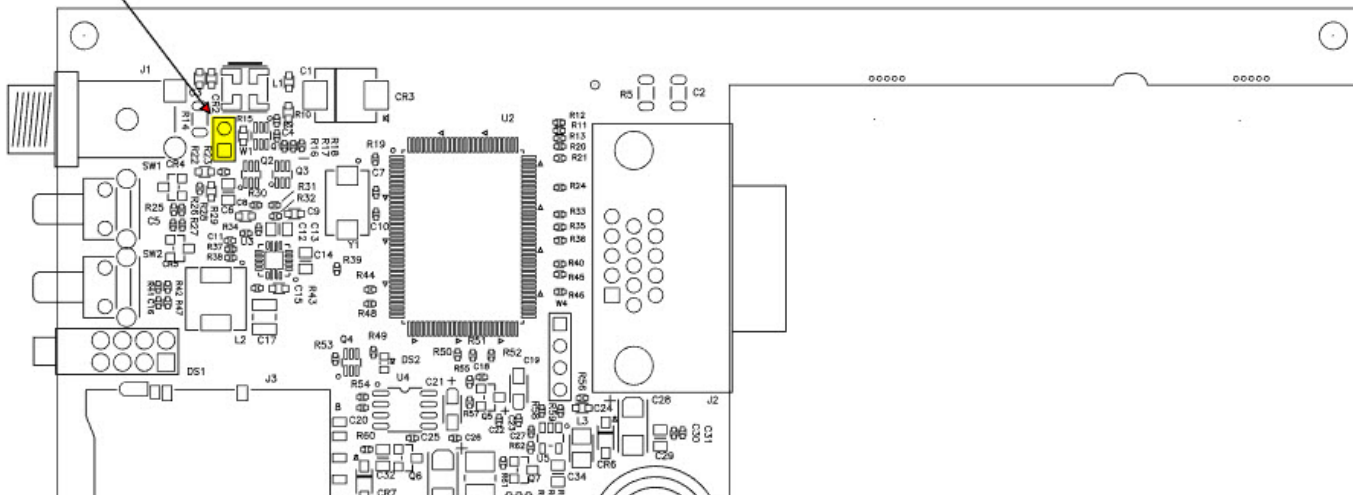

8. Slide the circuit board back into the enclosure.
9. Attach the front bezel and secure with the two bezel screws removed in step 5.
10. Secure the power connector with the nut and washer (removed in step 4) to the power connector, and attach the ground screw, Ethernet and power cables, and any USB devices.

To automatically run a schedule when the WebDAQ powers up, enable the "Automatically start schedule on system startup" option on the **Schedule Settings** dialog box of the web interface. If a power cycle occurs, the schedule will restart from the beginning, regardless of which job was running when the power was lost. In order to retain the data from each schedule start, make sure to set the logging option for each job to "Append Date/Time to File Name" so that each run after power loss creates a new data file rather than overwriting the original file. Refer to the WebDAQ help for details about how to configure schedule and logging options.

Enabling power-on mode with a complex or date/time triggered schedule

When running a complex or date/time-triggered schedule with both power-on mode and auto start schedule enabled, be aware that the schedule may not run automatically after a power cycle if the date or time trigger is no longer valid. In this case, the user may still access the WebDAQ remotely to modify the start settings.

Replacing the battery

A button cell lithium battery provides the time reference for WebDAQ hardware when the device is powered off. The average lifespan of the battery is approximately 10 years.

Caution! The discharge of static electricity can damage some electronic components. Before removing the WebDAQ from its housing, ground yourself using a wrist strap or touch the computer chassis or other grounded object to eliminate any stored static charge.

1. Power down the WebDAQ device and disconnect the power supply.
2. On the rear panel, remove the Ethernet cable, power cable, SD card, and any USB devices.

3. Remove the #6-32 ground screw.
4. Remove the nut and washer from the **EXT PWR** connector.
5. Remove the two front panel bezel screws and remove the front bezel.
6. Slide out the circuit board with the front panel intact.
7. Remove the battery by sliding it forward toward the slot, and replace with a 3 V lithium coin cell battery.
8. Slide the circuit board back into the enclosure.
9. Attach the front bezel and secure with the two bezel screws removed in step 5.
10. Secure the power connector with the nut and washer removed in step 4, to the power connector, attach the ground screw, Ethernet and power cables, and any USB devices.

Set the device system clock from the **Device** window, **Device Info** tab on the web interface.

Updating WebDAQ firmware

Device firmware is bundled with the operating system, web server, and documentation in a software update (*.swu) file. Firmware updates are posted on the [Measurement Computing Firmware Updates](#) page and are available for download.

Use the web interface to install the *.swu update file. Open a browser window and enter **http://webdaq-xxxxxx.local/Help**, where xxxxxx is the last 6 digits of the MAC address – see the label on the bottom of the enclosure. Refer to the "Updating WebDAQ Firmware" help topic or FAQ for instructions.

Calibrating the hardware

The Measurement Computing Manufacturing Test department performs the initial factory calibration. Return the device to Measurement Computing Corporation when calibration is required. The recommended calibration interval is one year.

[Contents](#)

Specifications

All specifications are subject to change without notice.

Typical for 0 °C to 50 °C unless otherwise specified.

Thermocouple input

Table 1. Thermocouple input specifications

Parameter	Condition	Specification
Number of channels		16 thermocouple channels 1 internal auto zero channel 1 internal cold-junction compensation channel
ADC resolution		24 bits
Type of ADC		Delta-Sigma
Sampling mode		Scanned
Voltage measurement range		±78.125 mV
Temperature measurement ranges		Works over temperature ranges defined by NIST (J, K, T, E, N, B, R, S thermocouple types)
Timing mode	Automatically set for either high-resolution or high-speed mode based on the requested scan rate, regardless of the number of channels.	<ul style="list-style-type: none"> ▪ High resolution: requested scan rate is ≤1 Hz ▪ High-speed: requested scan rate is >1 Hz
Timing mode	High-resolution	Conversion Time (per channel): 55 ms Sample Rate (all channels): 1 S/s
	High-speed	Conversion Time (per channel): 740 μs Sample Rate: 75 S/s/ch
Common-mode voltage range		Channel-to-COM: ±1.2 V min COM-to-earth ground: ±250 V
Common-mode rejection ratio (CMRR)	High-resolution mode at DC and 50 to 60 Hz	Channel-to-COM: 100 dB COM-to-earth ground: >170 dB
	High-speed mode at 0 to 60 Hz	Channel-to-COM: 70 dB COM-to-earth ground: >150 dB
Input bandwidth	High-resolution mode	14.4 Hz
	High-speed mode	78 Hz
High-resolution noise rejection	50 Hz and 60 Hz	60 dB
Overvoltage protection		±30 V between any two inputs

Differential input impedance		78 M Ω
Input current		50 nA
Input noise	High-resolution mode	200 nVrms
	High-speed mode	7 μ Vrms
Gain error	High-resolution mode	0.03% typ at 25 °C 0.07% typ at 0 °C to 60 °C 0.15% max at 0 °C to 60 °C
	High-speed mode	0.04% typ at 25 °C 0.08% typ at 0 °C to 60 °C 0.16% max at 0 °C to 60 °C
Offset error	High-resolution mode	4 μ V typ, 6 μ V max
	High-speed mode	14 μ V typ, 17 μ V max
Offset error from source impedance	0 °C to 60 °C	Add 0.05 μ V per Ω , when source impedance >50 Ω
Cold-junction compensation accuracy		0.8 °C typ, 1.7 °C max
Warm-up time	The device is lying flat or facing upward, with a constant ambient temperature.	15 minutes recommended

Temperature measurement accuracy

Measurement sensitivity represents the smallest change in temperature that a sensor can detect. It is a function of noise. The values assume the full measurement range of the standard thermocouple sensor per ASTM E230–87.

Table 2. Temperature accuracy specifications

Parameter	Condition	Specification
Measurement sensitivity	High-resolution mode	Type J, K, T, E, N: <0.02 °C Type B, R, S: <0.15 °C
	High-speed mode	Type J, K, T, E: <0.25 °C Type N: <0.35 °C Type B: <1.2 °C Type R, S: <2.8 °C

The following figures show the errors for each thermocouple type when connected to the WebDAQ 316 with auto zeroing performed. The figures display the maximum error over a full temperature range, and the typical error at room temperature. The figures account for gain errors, offset errors, differential and integral nonlinearity, quantization errors, noise errors, 50 Ω lead wire resistance, and cold-junction compensation errors. The figures do not account for the accuracy of the thermocouple itself.

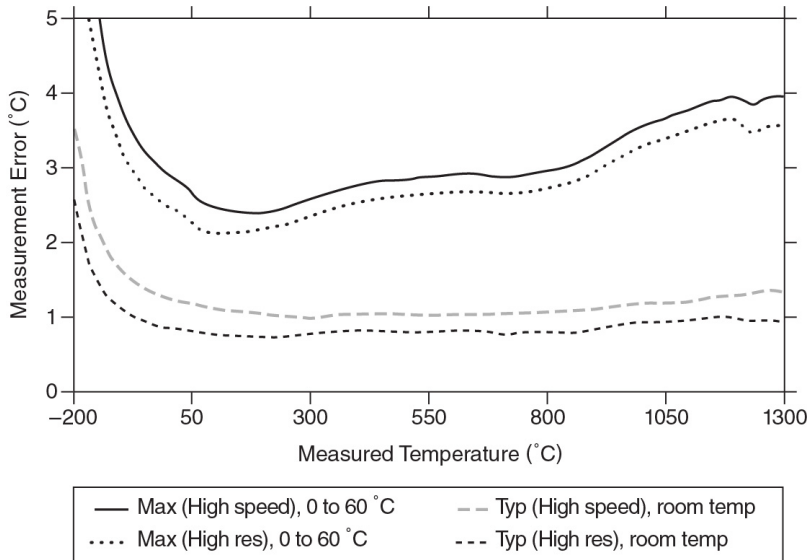

Thermocouple Types J and N Errors

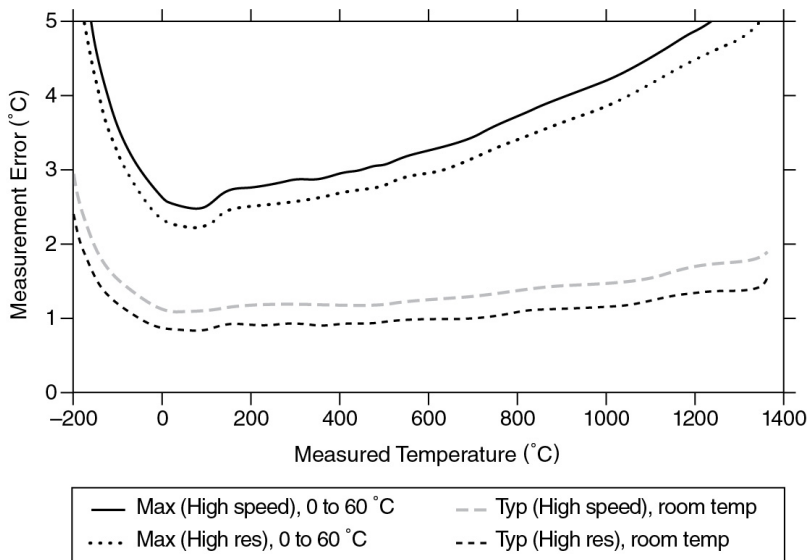

Thermocouple Type K Errors

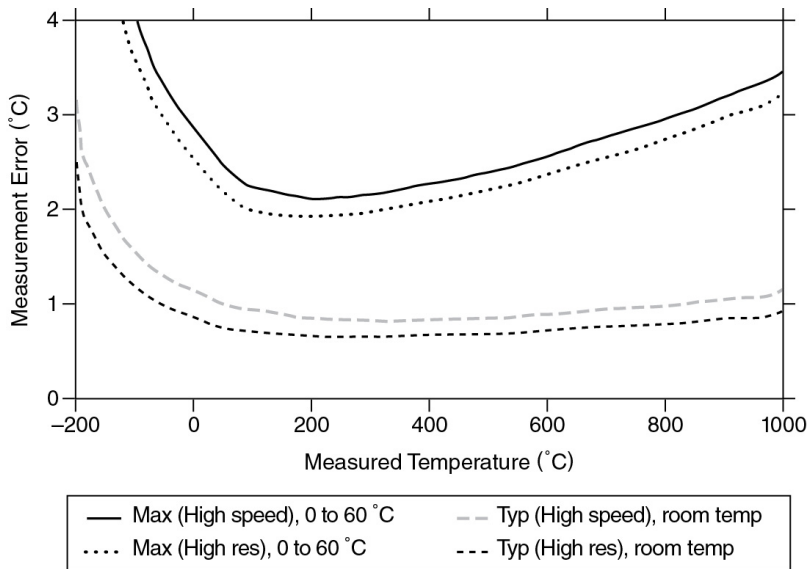

Thermocouple Type T and E Errors

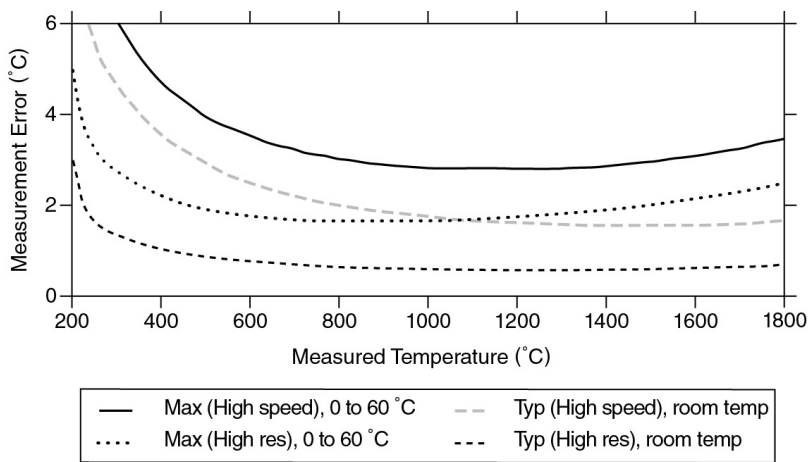

Thermocouple Type B Errors

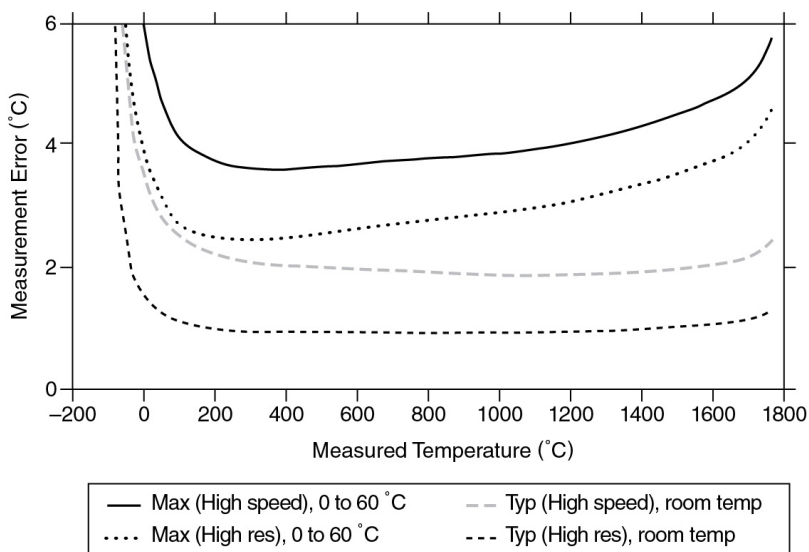

Thermocouple Type R and S Errors

Digital input/output

Table 3. Digital input/output specifications

Parameter	Specification
Digital type	CMOS (Schmitt trigger) input / open drain output
Number of I/O	One port of 4 bits
Configuration	Each bit can be independently configured for input or output
Power on conditions	Power on reset is input mode
Pull-up configuration	Each bit is pulled up to 5 V with a 100 k Ω resistor
Input frequency range	DC – 10 kHz (Note 1)
Input high voltage threshold	1.9 V min, 3.6 V max
Input low voltage threshold	2.3 V max, 1.0 V min
Schmitt trigger hysteresis	0.6 V min, 1.7 V max
Input high voltage limit	15 V max
Input low voltage limit	–0.5 V absolute min 0 V recommended min
Output voltage range	0 V to +5 V (no external pull up resistor) 0 V to +15 V max (Note 2)
Output off state leakage current	10 μ A max
Output sink current capability	100 mA max (continuous) per output pin
Output transistor on-resistance (drain to source)	1.6 Ω

Note 1. Applying a signal with a frequency higher than this specification will adversely affect system performance and could cause errors.

Note 2. The external pull-up resistor is connected between the digital output bit and an external supply. Adding an external pull-up resistor connects it in parallel with the internal 100 k Ω pull-up resistor of that particular digital input/output bit to the internal 5 V supply. Careful consideration should be made when considering the external pull-up resistor value and the resultant pull-up voltage produced at the load.

Network

Ethernet connection

Table 4. Ethernet connection specifications

Parameter	Specification
Ethernet type	100 Base-TX 10 Base-T
Communication rates	10/100 Mbps, auto-negotiated
Connector	RJ-45, 8 position
Cable length	100 meters (328 feet) max For CE compliance the max length is 3 meters (9.84 feet)
Additional parameters	HP Auto-MDIX support

Network configuration

Table 5. Network configuration

Parameter	Specification
Network IP configuration	DHCP, link-local, static DHCP may be disabled by the user and a static IP address assigned If DHCP is enabled but is unsuccessful at obtaining an IP address the device will fall back to link-local and request the IP address 169.254.100.100.
Network device name	The name used for detecting the device using mDNS (zero-conf). This name may be changed using the web interface.
Network name publication	By mDNS
User accounts	There are two built-in user accounts: <ul style="list-style-type: none"> ▪ admin ▪ share These accounts are case-sensitive and cannot be changed using the web interface.

Factory default settings

Table 6. Factory default settings

Parameter	Specification
Factory default IP address	192.168.0.101
Factory default subnet mask	255.255.255.0
Factory default gateway	192.168.0.1
Factory default DHCP setting	DHCP + link-local enabled
Factory default password for admin account	admin Passwords are case sensitive and can be changed using the web interface.
Factory default password for share account	share Passwords are case sensitive and can be changed using the web interface.
Factory default device name	webdaq-xxxxxx, where xxxxxx is the last 6 digits of the MAC address (printed on the label on the underside of the device).

Note 3. Shared folders and mapped drives are reset when factory defaults are restored.

Processor / Memory

Table 7. Processor / memory specifications

Parameter	Specification
Microprocessor	Type: Quad core Broadcom BCM2837 Speed: 1.2 GHz
Memory	RAM: 1 GB LPDDR2 Flash: 4 GB eMMC (3 GB available for user data storage)

USB ports

Table 8. USB specifications

Parameter	Specification
Number of USB ports	Two
USB device type	USB 2.0 (high-speed)
Device compatibility	USB 1.1, USB 2.0, USB 3.0

Note 4. The USB ports are provided for connection to a mass storage device or approved WiFi adapter.

SD memory card slot

Table 9. SD card specifications

Parameter	Specification
Memory card type	SD, SDHC, SDXC, MMC, TransFlash
File systems supported	FAT16, FAT32, exFAT, ext2/3/4, NTFS

LED indicators

Table 10. LED specifications – normal operating mode

Label	State	Description
1: POWER	Steady yellow	Device is booting up.
	Steady green	Device boot is successful.
	Blinking yellow	Device is shutting down.
	Off	Device is off.
2: STATUS	Blinking yellow	Device is configuring hardware.
	Steady green	Hardware configuration is complete.
	Flashing green 100 ms on, 2s off	Waiting for the schedule start condition to be met. (Note 5)
	Blinking heartbeat	The configured schedule start condition is met; waiting for job start condition to be met. (Note 5)
	Blinking green	The configured job start condition is met – the job is running. (Note 5)
	Off	Device is off.
3: ERROR	Blinking yellow	Error condition is detected. LED blinks even when the software is configured to ignore the error. Error state is cleared on the next schedule start.
	Off	No error is detected, or the device is off
4: MEDIA	Blinking yellow	A job is configured to log to external media, but the job hasn't started yet; push button will not let you eject media.
	Steady yellow	External media is inserted into the SD card slot or USB storage port.
	Blinking green	Currently logging to an external SD card or USB storage device.
	Steady green	Media has been made safe for removal using the FUNC button, but is still inserted in the device.
	Off	No external media is detected, or the device is off.

Note 5. Use the WebDAQ software to configure start and stop settings for jobs and schedules.

Table 11. LED specifications – software update mode

LED	State	Description
All LEDs	Solid yellow	Software update is starting.
1. POWER	Blinking yellow	Software update is running.
2. STATUS	Blinking green	Update file is located; device is being updated.
	Blinking yellow	Update file cannot be located; insert media containing the update file.
3. ERROR	Blinking green	Update is successful; device reboot in approximately 5 seconds.
	Blinking yellow	Update failed; user must retry.

Push buttons

Table 12. Push button specifications

Component	Label	Description
Power button	POWER	<p>W1 jumper installed (factory default) (Note 6)</p> <ul style="list-style-type: none"> ▪ When device is off; press briefly to turn the device on ▪ When device is on: <ul style="list-style-type: none"> ▪ Press for ~1 second to shuts down the device; release the button when the POWER LED blinks yellow ▪ Press and hold ~4 seconds to force the device to power off <p>W1 jumper removed (Note 6):</p> <ul style="list-style-type: none"> ▪ Device will always be on if power is applied ▪ Press for ~1 second to reboot the device; release the button when the POWER LED blinks yellow
Function button	FUNC	<p>Dual function:</p> <ul style="list-style-type: none"> ▪ Ejects, or safely unmounts, all removable media for safe removal from the device (default) ▪ This function is disabled when a job that uses external media is running ▪ The MEDIA LED is steady green when all media is unmounted but still inserted in the device ▪ Starts or stops an acquisition; requires configuration via the web interface
Factory reset button	CONFIG RESET	Restores network settings to factory default values; refer to the Factory default settings table for values.

Note 6. Refer to this [circuit board image](#) for the location of the W1 jumper.

Ground connector

Table 13. Ground connector specifications

Component	Label	Description
Ground connector	#6-32	Connector port for the #6-32 ground screw

Power

Table 14. Power specifications

Parameter	Conditions	Specification
Input voltage	Center positive	6 VDC to 16 VDC
Input wattage		4 W typ, 10 W max
External power adapter	p/n PS-9V1AEPS230V (Note 7)	Phihong PSC15R-090 15 W adapter included. 9 volts, 1.67 amps, 110 VAC to 240 VAC input range required.
Power behavior	W1 jumper installed (factory default)	Soft power on using the momentary power button; device can turn its power off to shut down. Device does not resume operation if power is lost.
	W1 jumper removed	Device is always on if power is applied. Power button functions only as a reboot button.
Battery		One 3 V button cell lithium battery required to maintain time of day clock when device is powered off.
Battery replacement		Panasonic BR-1225 3V lithium coin cell battery or equivalent; user-replaceable. Refer to the Replacing the Battery section for the replacement procedure.

Note 7. If using a different supply, ensure that it has a positive center pin.

Mechanical

Table 15. Mechanical specifications

Parameter	Specification
Dimensions (L × W × H)	158.8 × 146.1 × 38.1 mm (6.25 × 5.75 × 1.50 in.) 177.0 × 146.1 × 38.1 mm (6.97 × 5.75 × 1.50 in.) includes spring terminal
Weight	635 g (1.45 lb)

Environmental

Table 16. Environmental specifications

Parameter	Specification
Operating temperature range	0 °C to 50 °C max
Storage temperature range	−40 °C to 85 °C
Ingress protection	IP30
Operating humidity	10% to 90% RH, noncondensing
Storage humidity	5% to 95% RH, noncondensing
Maximum altitude	2,000 m (6,562 ft)
Pollution Degree	2

Note 8. WebDAQ operation is intended for indoor use only, but may be used outdoors if installed in a suitable enclosure.

Safety voltages

Connect only voltages that are within the limits specified in this table.

Table 17. Safety specifications

Parameter	Conditions	Specification
Between any two terminals		±30 V max
Channel-to-channel isolation		None
Channel-to-earth ground isolation	Continuous	60 VDC for analog inputs, 15 VDC for DIO, CAT I
	Withstand	60 VDC, verified by a 5 second dielectric withstand test

Measurement Category I is for measurements performed on circuits not directly connected to the electrical distribution system referred to as MAINS voltage. MAINS is a hazardous live electrical supply system that powers equipment. This category is for measurements of voltages from specially protected secondary circuits. Such voltage measurements include signal levels, special equipment, limited-energy parts of equipment, circuits powered by regulated low-voltage sources, and electronics.

Measurement Categories CAT I and CAT O are equivalent. These test and measurement circuits are for other circuits not intended for direct connection to the MAINS building installations of Measurement Categories CAT II, CAT III, or CAT IV.

Caution! Do not connect the WebDAQ 316 to signals or use for measurements within Measurement Categories II, III or IV.

Signal connectors

Table 18. Screw terminal specifications

Parameter	Specification
Connector types	36-position spring terminal for thermocouple connections 6-position screw terminal for digital connections
Screw terminal wiring	14 to 30 AWG copper conductor wire with 5 to 6 mm (0.20 to 0.24 in.) of insulation stripped from the end
Spring terminal wiring	16 to 28 AWG copper conductor wire with 7 mm (0.28 in.) of insulation stripped from the end

Screw terminal

Table 19. Screw terminal pinout

Terminal			Terminal		
#	Label	Use	#	Label	Use
1	GND	Digital ground	4	DIO2	Digital bit 2
2	DIO0	Digital bit 0	5	DIO3	Digital bit 3
3	DIO1	Digital bit 1	6	GND	Digital ground

Spring terminal

Table 20. Spring terminal pinout

Terminal			Terminal		
#	Label	Use	#	Label	Use
1	NC	No connection	29	NC	No connection
2	TC0[+]	Channel 0 HI	30	TC0[-]	Channel 0 LO
3	TC1[+]	Channel 1 HI	31	TC1[-]	Channel 1 LO
4	TC2[+]	Channel 2 HI	32	TC2[-]	Channel 2 LO
5	TC3[+]	Channel 3 HI	33	TC3[-]	Channel 3 LO
6	TC4[+]	Channel 4 HI	34	TC4[-]	Channel 4 LO
7	TC5[+]	Channel 5 HI	35	TC5[-]	Channel 5 LO
8	TC6[+]	Channel 6 HI	36	TC6[-]	Channel 6 LO
9	TC7[+]	Channel 7 HI	37	TC7[-]	Channel 7 LO
10	TC8[+]	Channel 8 HI	38	TC8[-]	Channel 8 LO
11	TC9[+]	Channel 9 HI	39	TC9[-]	Channel 9 LO
12	TC10[+]	Channel 10 HI	40	TC10[-]	Channel 10 LO
13	TC11[+]	Channel 11 HI	41	TC11[-]	Channel 11 LO
14	TC12[+]	Channel 12 HI	42	TC12[-]	Channel 12 LO
15	TC13[+]	Channel 13 HI	43	TC13[-]	Channel 13 LO
16	TC14[+]	Channel 14 HI	44	TC14[-]	Channel 14 LO
17	TC15[+]	Channel 15 HI	45	TC15[-]	Channel 15 LO
18	COM	Common	46	COM	Common

[Contents](#)

EU Declaration of Conformity

EU Declaration of Conformity

According to ISO/IEC 17050-1:2010

Manufacturer: Measurement Computing Corporation

Address: 10 Commerce Way

Norton, MA 02766

USA

Product Category: Electrical equipment for measurement, control and laboratory use.

Date and Place of Issue: May 31, 2017, Norton, Massachusetts USA

Test Report Number: EMI7018.17

Measurement Computing Corporation declares under sole responsibility that the product
WebDAQ 316

is in conformity with the relevant Union Harmonization Legislation and complies with the essential requirements of the following applicable European Directives:

Electromagnetic Compatibility (EMC) Directive 2014/30/EU

RoHS Directive (EU) 2015/863 amending Annex II to Directive 2011/65/EU

Conformity is assessed in accordance to the following standards:

EMC:

Emissions:

- EN 61326-1:2013 (IEC 61326-1:2012), Class A
- EN 55011: 2009 + A1:2010 (IEC CISPR 11:2009 + A1:2010), Group 1, Class A

Immunity:

- EN 61326-1:2013 (IEC 61326-1:2012), Controlled EM Environments
- EN 61000-4-2:2008 (IEC 61000-4-2:2008)
- EN 61000-4-3 :2010 (IEC61000-4-3:2010)
- EN 61000-4-4 :2012 (IEC61000-4-4:2012)
- EN 61000-4-5 :2014 (IEC61000-4-5:2014)
- EN 61000-4-6 :2013 (IEC61000-4-6:2013)
- EN 61000-4-11:2004 (IEC61000-4-11:2004)

Environmental Affairs:

Articles manufactured on or after the Date of Issue of this Declaration of Conformity do not contain any of the restricted substances in concentrations/applications not permitted by the RoHS Directive.

Carl Haapaoja, Director of Quality Assurance

[Contents](#)

Measurement Computing Corporation

10 Commerce Way

Norton, MA 02766

Phone: 508-946-5100

mccdaq.com/support