

# CIO-DIO24

24 Digital I/O Bits, CMOS TTL, One 82C55 Chip

## User's Guide



# CIO-DIO24

## Digital Input/Output Board

### User's Guide



**MEASUREMENT  
COMPUTING™**

Document Revision 1A, January, 2007

© Copyright 2007, Measurement Computing Corporation

## Trademark and Copyright Information

Measurement Computing Corporation, InstaCal, Universal Library, and the Measurement Computing logo are either trademarks or registered trademarks of Measurement Computing Corporation. Refer to the Copyrights & Trademarks section on [mccdaq.com/legal](http://mccdaq.com/legal) for more information about Measurement Computing trademarks. Other product and company names mentioned herein are trademarks or trade names of their respective companies.

© 2012 Measurement Computing Corporation. All rights reserved. No part of this publication may be reproduced, stored in a retrieval system, or transmitted, in any form by any means, electronic, mechanical, by photocopying, recording, or otherwise without the prior written permission of Measurement Computing Corporation.

### Notice

Measurement Computing Corporation does not authorize any Measurement Computing Corporation product for use in life support systems and/or devices without prior written consent from Measurement Computing Corporation. Life support devices/systems are devices or systems that, a) are intended for surgical implantation into the body, or b) support or sustain life and whose failure to perform can be reasonably expected to result in injury. Measurement Computing Corporation products are not designed with the components required, and are not subject to the testing required to ensure a level of reliability suitable for the treatment and diagnosis of people.

---

# Table of Contents

<b>Preface</b>	
<b>About this User's Guide .....</b>	<b>6</b>
What you will learn from this user's guide .....	6
Conventions in this user's guide .....	6
Where to find more information .....	6
<b>Chapter 1</b>	
<b>Introducing the CIO-DIO24 .....</b>	<b>7</b>
Overview: CIO-DIO24 features .....	7
Software features .....	7
<b>Chapter 2</b>	
<b>Installing the CIO-DIO24 .....</b>	<b>8</b>
What comes with your CIO-DIO24 shipment? .....	8
Hardware .....	8
Additional documentation .....	8
Optional components .....	8
Unpacking the CIO-DIO24 .....	9
Installing the software .....	9
Configuring the CIO-DIO24 .....	9
Base address .....	10
Interrupt level .....	11
Wait state .....	12
Installing the CIO-DIO24 .....	12
Connecting the board for I/O operations .....	13
Connectors, cables – main I/O connector .....	13
Cabling .....	14
Field wiring, signal termination, and conditioning .....	14
<b>Chapter 3</b>	
<b>Functional Details .....</b>	<b>15</b>
Signal level control .....	15
Digital I/O Isolation .....	16
<b>Chapter 4</b>	
<b>Programming and Developing Applications .....</b>	<b>17</b>
Programming languages .....	17
Packaged applications programs .....	17
Register-level programming .....	17
<b>Chapter 5</b>	
<b>Specifications .....</b>	<b>18</b>
Digital Input / Output .....	18
Power consumption .....	18
Environmental .....	18
Main connector and pin out .....	19

---

## About this User's Guide

### What you will learn from this user's guide

This user's guide describes the Measurement Computing CIO-DIO24 data acquisition board and lists hardware specifications.

### Conventions in this user's guide

**For more information**

Text presented in a box signifies additional information related to the subject matter.

**Caution!** Shaded caution statements present information to help you avoid injuring yourself and others, damaging your hardware, or losing your data.

**bold text**     **Bold** text is used for the names of objects on a screen, such as buttons, text boxes, and check boxes.

*italic text*     *Italic* text is used for the names of manuals and help topic titles, and to emphasize a word or phrase.

### Where to find more information

Additional information about CIO-DIO24 hardware is available on our website at [www.mccdaq.com](http://www.mccdaq.com). You can also contact Measurement Computing Corporation with specific questions.

- Knowledgebase: [kb.mccdaq.com](http://kb.mccdaq.com)
- Tech support form: [www.mccdaq.com/support/support\\_form.aspx](http://www.mccdaq.com/support/support_form.aspx)
- Email: [techsupport@mccdaq.com](mailto:techsupport@mccdaq.com)
- Phone: 508-946-5100 and follow the instructions for reaching Tech Support

For international customers, contact your local distributor. Refer to the International Distributors section on our website at [www.mccdaq.com/International](http://www.mccdaq.com/International).

# Introducing the CIO-DIO24

## Overview: CIO-DIO24 features

The CIO-DIO24 has 24 digital I/O connections, and one 82C55 parallel-interface chip.

Each 82C55 chip controls 24 CMOS/TTL-compatible digital I/O pins. The 82C55 is configured as two 8-bit ports and two 4-bit ports. Each port is programmable for input or output.

All I/O bits are set to input mode (high impedance) on power up and reset. If you are using the board to control items that must be OFF on reset, install pull-down resistors. The board is equipped with open locations where you can install SIP resistor networks for either pull-up or pull-down.

All signals pass through a 37-pin connector.

## Software features

For information on the features of *InstaCal* and the other software included with your CIO-DIO24, refer to the *Quick Start Guide* that shipped with your device. The *Quick Start Guide* is also available in PDF at [www.mccdaq.com/PDFmanuals/DAQ-Software-Quick-Start.pdf](http://www.mccdaq.com/PDFmanuals/DAQ-Software-Quick-Start.pdf).

Check [www.mccdaq.com/download.htm](http://www.mccdaq.com/download.htm) for the latest software version.

## Installing the CIO-DIO24

### What comes with your CIO-DIO24 shipment?

The following items are shipped with the CIO-DIO24.

#### Hardware

- CIO-DIO24



#### Additional documentation

In addition to this hardware user's guide, you should also receive the *Quick Start Guide* (available in PDF at [www.mccdaq.com/PDFmanuals/DAQ-Software-Quick-Start.pdf](http://www.mccdaq.com/PDFmanuals/DAQ-Software-Quick-Start.pdf)). This booklet supplies a brief description of the software you received with your CIO-DIO24 and information regarding installation of that software. Please read this booklet completely before installing any software or hardware.

### Optional components

- Cables



C37FF-x



C37FFS-x

- Signal termination and conditioning accessories

MCC provides signal conditioning and termination products for use with the CIO-DIO24. Refer to [Field wiring, signal termination, and conditioning](#) on page 14 for a complete list of compatible accessory products.

## Unpacking the CIO-DIO24

As with any electronic device, you should take care while handling to avoid damage from static electricity. Before removing the CIO-DIO24 from its packaging, ground yourself using a wrist strap or by simply touching the computer chassis or other grounded object to eliminate any stored static charge.

If any components are missing or damaged, notify Measurement Computing Corporation immediately by phone, fax, or e-mail:

- Phone: 508-946-5100 and follow the instructions for reaching Tech Support.
- Fax: 508-946-9500 to the attention of Tech Support
- Email: [techsupport@mccdaq.com](mailto:techsupport@mccdaq.com)

## Installing the software

Refer to the *Quick Start Guide* for instructions on installing the software on the *Measurement Computing Data Acquisition Software CD*. This booklet is available in PDF at [www.mccdaq.com/PDFmanuals/DAQ-Software-Quick-Start.pdf](http://www.mccdaq.com/PDFmanuals/DAQ-Software-Quick-Start.pdf).

## Configuring the CIO-DIO24

The CIO-DIO24 has a bank of base address-select switches, an interrupt level select jumper, and a wait-state jumper. The *InstaCal* calibration and test program included with the CIO-DIO24 will show you how to configure the board. Run *InstaCal* to verify or change their settings before installing the board in your computer.

The location of each switch and jumper on the CIO-DIO24 is shown in Figure 1.

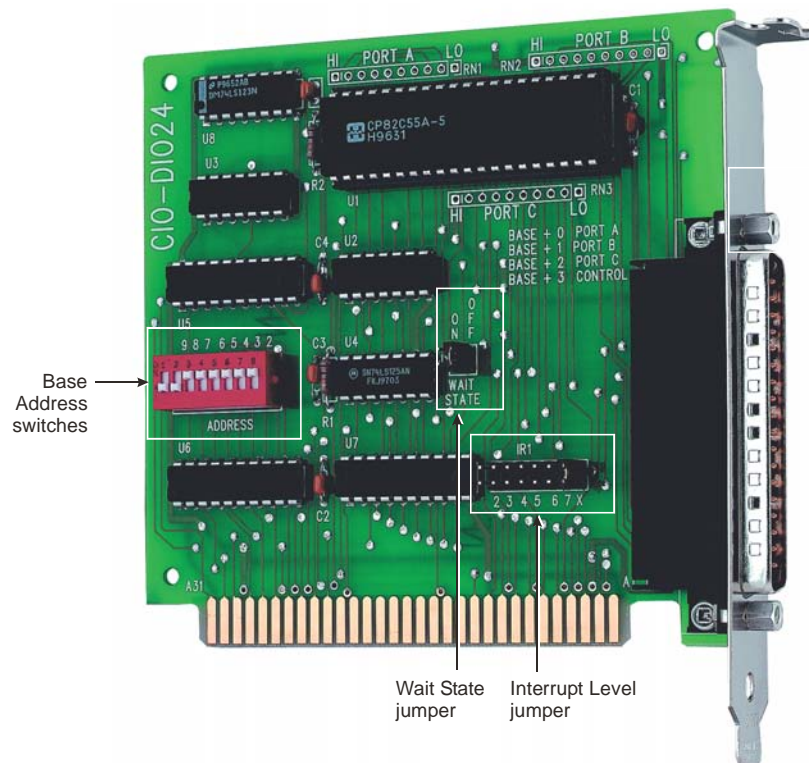

Figure 1. Switch and jumper locations

The CIO-DIO24 is shipped with the factory-default settings listed in the table below.



## Factory-configured default settings

Switch/jumper	Description	Default setting
Base address DIP switches	Sets the base address	300h (768 decimal)
Interrupt level jumper	Sets the interrupt level	"X" position (no interrupt level set)
Wait State jumper	Enables/disables the on-board wait-state generator.	Off (disabled)

Review the following information to change the default configuration of a switch or jumper.

## Base address

The easiest way to set the base address is to let *InstaCal* show you the correct settings. However, if you are already familiar with setting ISA base addresses, you may use the base address switch description below to guide your base address selection.

Each I/O board uses one or more I/O address locations within your computer's I/O address space. To avoid interference with other installed boards, each board must use unique addresses. The *base address* is the board's starting location that software writes to when communicating with the CIO-DIO24. A set of DIP switches is used to set the base address. By placing the switch down, the CIO-DIO24 address decode logic is instructed to respond to that address bit. A complete address is constructed by calculating the HEX or decimal number which corresponds to all the address bits the board has been instructed to respond to.

The board is shipped with the base address set to 300 hex (see Figure 2). Unless there is already a board in your system that uses address 300 hex (768 decimal), leave the switches as they were set at the factory.

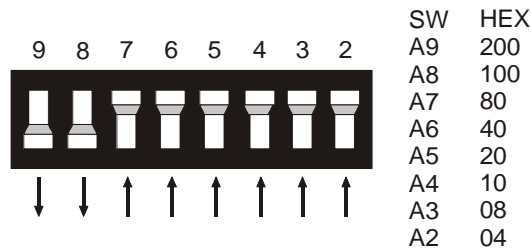

Figure 2. Base address switch

In the default configuration, addresses 9 and 8 are *down*, and all others are *up*. Address 9 = 200 hex (512 decimal), and address 8 = 100 hex (256 decimal). When added together they equal 300 hex (768 decimal).

### Disregard the numbers printed on the switch

When setting the base address, refer to the numbers printed in white on the printed circuit board.

Certain addresses are used by the computer. Other addresses are free, and may be used by the CIO-DIO24. Refer to the following table for a list of I/O addresses.

### PC I/O Address Summary

Hex Range	Function	Hex Range	Function
000-00F	8237 DMA #1	2C0-2CF	EGA
020-021	8259 PIC #1	2D0-2DF	EGA
040-043	8253 TIMER	2E0-2E7	GPIB (AT)
060-063	8255 PPI (XT)	2E8-2EF	SERIAL PORT
060-064	8742 CONTROLLER (AT)	2F8-2FF	SERIAL PORT
070-071	CMOS RAM & NMI MASK (AT)	300-30F	PROTOTYPE CARD
080-08F	DMA PAGE REGISTERS	310-31F	PROTOTYPE CARD

Hex Range	Function	Hex Range	Function
0A0-0A1	8259 PIC #2 (AT)	320-32F	HARD DISK (XT)
0A0-0AF	NMI MASK (XT)	378-37F	PARALLEL PRINTER
0C0-0DF	8237 #2 (AT)	380-38F	SDLC
0F0-0FF	80287 NUMERIC CO-P (AT)	3A0-3AF	SDLC
1F0-1FF	HARD DISK (AT)	3B0-3BB	MDA
200-20F	GAME CONTROL	3BC-3BF	PARALLEL PRINTER
210-21F	EXPANSION UNIT (XT)	3C0-3CF	EGA
238-23B	BUS MOUSE	3D0-3DF	CGA
23C-23F	ALT BUS MOUSE	3E8-3EF	SERIAL PORT
270-27F	PARALLEL PRINTER	3F0-3F7	FLOPPY DISK
2B0-2BF	EGA	3F8-3FF	SERIAL PORT

You can set the base address switch to any address in the range of 000-3FC. If you are not using IBM prototyping cards or another board which occupies these addresses, the CIO-DIO24 board's default address of 300h is free to use.

Addresses not specifically listed, such as 390-39Fh, are not reserved and may be available. Check your computer for other boards which may use I/O addresses.

## Interrupt level

The trigger logic on the CIO-DIO24 is quite simple. Pin 1 (**IR Input**) of the board's 37-pin connector is an input jumper which maps the interrupt directly onto the PC bus. The signal to the bus is buffered. The buffer is enabled by a LOW level on Pin 2, **IR Enable**.

Interrupts are hardware-initiated software routines. Most hardware interrupts are assigned by the computer and are reserved for internal system use. Refer to the following table for some typical interrupt assignments on a computer.

The CIO-DIO24 is shipped with the jumper in the "X" position, which means that no interrupt level is set (Figure 3). Leave the jumper in the default "X" position for now. If your software employs interrupt service routines, it will direct you to select an IRQ level. Use the jumper block labeled **IR1** above the PC bus interface (gold pins) if you want to set the interrupt.

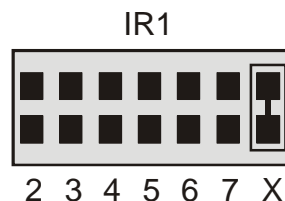

Figure 3. Interrupt level select jumper (no interrupt level set)

## Hardware interrupt assignments

Name	Description	Name	Description
NMI	Parity	IRQ8	Real Time Clock (AT)
IRQ0	Timer	IRQ9	Re-directed to IRQ2
(AT)			
IRQ1	Keyboard	IRQ10	Unassigned
IRQ2	Reserved (XT)	IRQ11	Unassigned
	INT 8-15 (AT)		
IRQ3	COM OR SDLC	IRQ12	Unassigned
IRQ4	COM OR SDLC	IRQ13	80287 MUNERIC CO-P
IRQ5	Hard Disk (XT)	IRQ14	Hard Disk
	LPT (AT)		
IRQ6	Floppy Disk	IRQ15	Not assigned
IRQ7	LPT		

## Wait state

The CIO-DIO24 board has a wait state jumper which you can set to enable an on-board wait state generator (see Figure 4). A wait state is an extra delay injected into the processor's clock via the bus. This delay slows down the processor when the processor addresses the CIO-DIO24 board, so that signals from slow devices (chips) will be accepted. The wait state generator is only active when the CIO-DIO24 is being accessed. Your PC will not be slowed down in general by using the wait state.

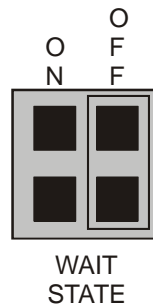

Figure 4. Wait state jumper

The jumper is shown in Figure 4 is configured for **OFF** (wait state is disabled).

Because all PC expansion board busses are slowed to either 8 MHz or 10 MHz, the wait state will generally not be required. If you experience sporadic errors from the 82C55 digital I/O chip (reset, port direction swaps), try enabling the wait state generator.

## Installing the CIO-DIO24

After you configure the base address, you can install the CIO-DIO24 into your computer. Follow the steps below.

### Install the MCC DAQ software before you install your board

The driver needed to run your board is installed with the MCC DAQ software. Therefore, you need to install the MCC DAQ software before you install your board. Refer to the *Quick Start Guide* for instructions on installing the software.

1. Turn your computer off, open it up, and insert your board into an available ISA slot.
2. Close your computer and turn it on.
3. To test your installation and configure your board, run the *InstaCal* utility you installed in the previous section. Refer to the *Quick Start Guide* that came with your board [www.mcdaq.com/PDFmanuals/DAQ-Software-Quick-Start.pdf](http://www.mcdaq.com/PDFmanuals/DAQ-Software-Quick-Start.pdf) for information on how to initially set up and load *InstaCal*.

## Connecting the board for I/O operations

### Connectors, cables – main I/O connector

The table below lists the board connector, applicable cables, and compatible accessory products.

Board connector, cables, and accessory equipment

Connector type	37-pin male "D" connector
Compatible cables	C37FF-x C37-FFS-x DFCON-37 (D-connector, D-shell, and termination pins to construct your own cable)
Compatible accessory products with the C37FF-x cable and C37FFS-x cable	CIO-MINI37 CIO-SPADE50 SSR-RACK08 SSR-RACK24 CIO-ERB08 CIO-ERB24

The CIO-DIO24 connector is a 37-pin D-type male connector that is accessible through the computer's expansion bracket (see Figure 5). The signals available are direct connections to the 82C55 digital I/O chip as well as the PC's internal power supplies.

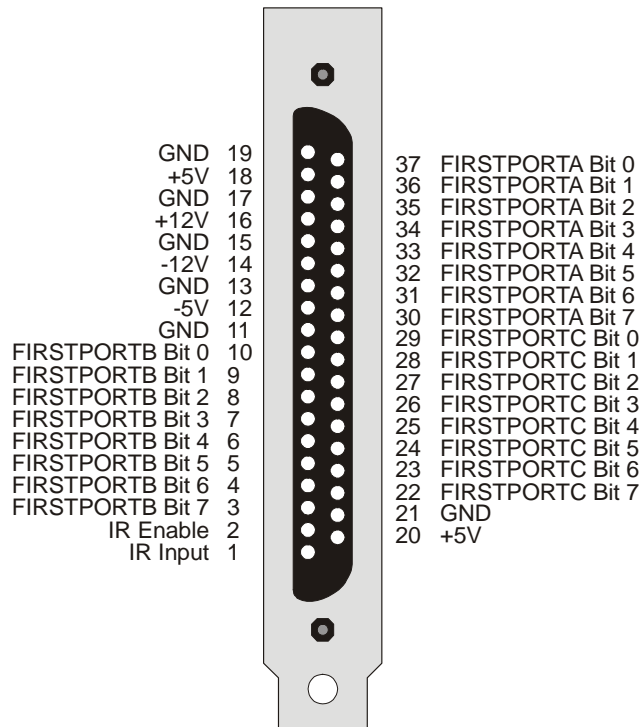

Figure 5. I/O connector pin-out

## Cabling

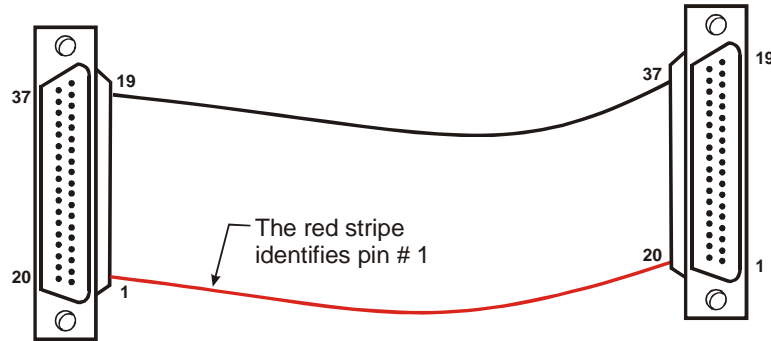

Figure 6. C37FF-x cable

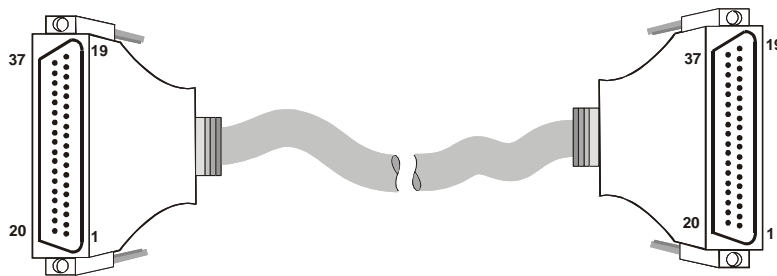

Figure 7. C37FFS-x cable

## Field wiring, signal termination, and conditioning

You can use the following cabling, screw termination, and signal conditioning products with the CIO-DIO24.

- CIO-MINI37 – 37-pin screw terminal board.
- CIO-SPADE50 – 16" X 4" termination panel which mates with both 37-pin and 50-pin connectors.
- CIO-MINI50 – 50-pin screw terminal board.
- SSR-RACK24 – 24-channel, solid-state relay mounting rack for digital signal conditioning.
- SSR-RACK48 – 48-channel, solid-state relay mounting rack with quad-format modules.
- CIO-ERB24 – 24 Form C relays, 6 Amp relay accessory board for digital signal conditioning.
- CIO-ERB48 – 48 Form C relays, 6 Amp, relay, 50-pin accessory board for digital signal conditioning.

### Information on signal connections

General information regarding signal connection and configuration is available in the *Guide to Signal Connections*. This document is available on our web site at [www.mccdaq.com/signals/signals.pdf](http://www.mccdaq.com/signals/signals.pdf).

## Functional Details

All of the digital outputs and inputs are CMOS TTL (Transistor-Transistor Logic). TTL is an industry term that describes a standard for digital signals which are either at 0 V or 5 V (nominal).

The voltages and currents associated with external devices range from less than a hundred mA at a few volts for lamps etc., to 50 Amps at 220 volts for electric heaters or other high-load equipment. Attempting to connect such loads directly to the CIO-DIO24 will damage the I/O chip. Heavy loads such as these require external relays.

### Digital Interfacing

In addition to load matching, digital signal sources often need to be filtered or "de-bounced". Refer to the *Guide to Signal Connections* at [www.mccdaq.com/signals/signals.pdf](http://www.mccdaq.com/signals/signals.pdf) for information on digital interfacing.

## Signal level control

The 82C55 digital I/O chip initializes all ports as inputs on power-up and reset. A TTL input is a high impedance input. If you connect another TTL input device to the 82C55 it could be turned ON or OFF every time the 82C55 is reset.

To prevent unwanted signal levels, and to drive all inputs on the device you are controlling to a known state after power up or reset, install pull-up or pull-down resistors. If you are using the board to control items that must be OFF on reset, install pull-down resistors.

A pull-up resistor pulls all digital pins up to +5 V (high logic level). A pull-down resistor pulls all digital pins down to 0 V (low logic level).

The CIO-DIO24 has open locations where you can install a single inline package (SIP) resistor network for each port. When installed, the SIP establishes either a high or low logic level at each of the I/O lines on the port.

The SIP is made up of eight 2.2 K $\Omega$  resistors. One side of each resistor is connected to a single common point and brought out to a pin. The common line is marked with a dot or line at one end of the SIP. The remaining resistor ends are brought out to the other eight pins (see Figure 8).

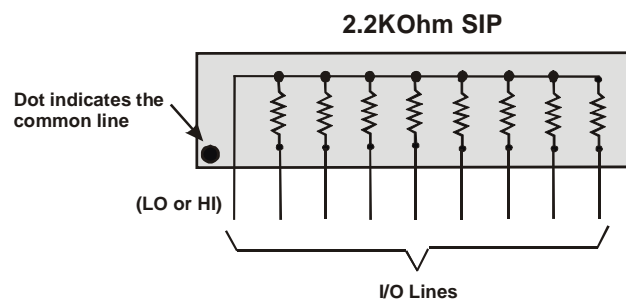

Figure 8. Eight-resistor SIP schematic

Install the SIP on the CIO-DIO24 board at the locations labeled PORT A, PORT B and PORT C. Figure 9 shows a schematic of an SIP installed in both the pull-up and pull-down positions. Each port provides 10 holes in a line. The end labeled **HI** connects to +5V. The end marked **LO** connects to GND. The eight holes in the middle (n0 –n7) connect to the eight lines of the Port, A, B or C.

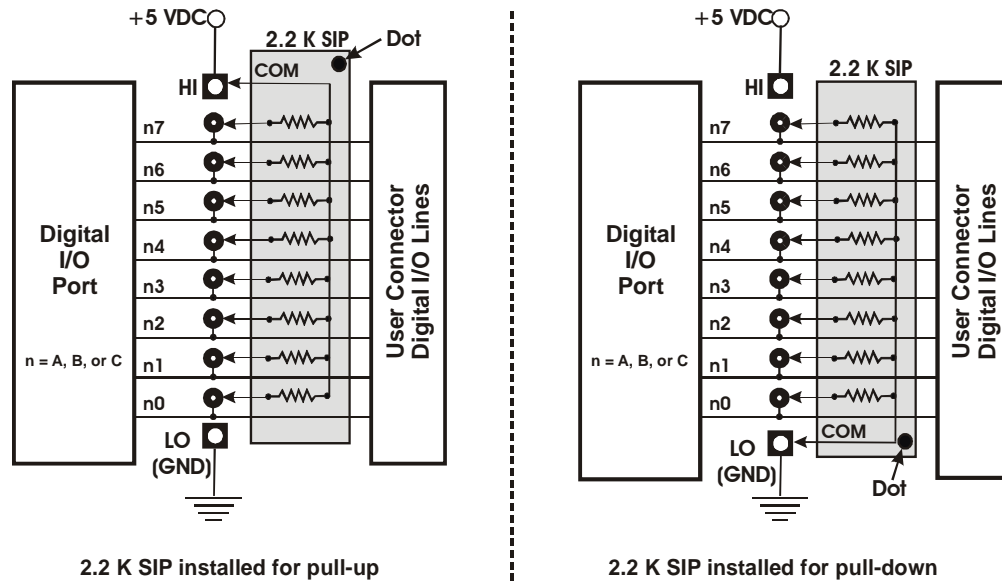

Figure 9. Pull-up and pull-down resistor SIPs schematic

To pull-up lines, orient the SIP with the common pin (dot) toward the **HI** end; to pull-down, install the resistor with the common pin in the **LO** hole.

When installing pull-up and pull-down resistor SIP packs, we recommend using 2.2K, eight-resistor Single Inline Packages (MCC part number SP-K2.29C). Use a different value only if necessary.

#### Unconnected inputs float

Unconnected inputs typically float high, but not reliably. If you are using a CIO-DIO24 for input and have unconnected inputs, ignore the data from those lines. You do not have to terminate input lines. Unconnected lines will not affect the performance of connected lines. Mask out any unconnected bits in software.

## Digital I/O Isolation

To provide external signal conditioning and isolation, you can connect the CIO-DIO24 to a CIO-ERB24 or SSR-RACK24. The CIO-ERB24 provides 24 Form C electromechanical relays. The SSR-RACK24 is a mounting rack for 24 solid-state relays.

---

# Programming and Developing Applications

After following the installation instructions in Chapter 2, your board should now be installed and ready for use. In general there may be no correspondence among registers for different boards. Software written at the register level for other models will not function correctly with your board.

## Programming languages

Measurement Computing's Universal Library provides access to board functions from a variety of Windows programming languages. If you are planning to write programs, or would like to run the example programs for Visual Basic® or any other language, refer to the *Universal Library User's Guide* (available on our web site at [www.mccdaq.com/PDFmanuals/sm-ul-user-guide.pdf](http://www.mccdaq.com/PDFmanuals/sm-ul-user-guide.pdf)).

## Packaged applications programs

Many packaged application programs now have drivers for your board. If the package you own does not have drivers for your board, please fax or e-mail the package name and the revision number from the install disks. We will research the package for you and advise how to obtain drivers.

Some application drivers are included with the Universal Library package, but not with the application package. If you have purchased an application package directly from the software vendor, you may need to purchase our Universal Library and drivers. Please contact us by phone, fax or e-mail:

- Phone: 508-946-5100 and follow the instructions for reaching Tech Support.
- Fax: 508-946-9500 to the attention of Tech Support
- Email: [techsupport@mccdaq.com](mailto:techsupport@mccdaq.com)

## Register-level programming

You should use the Universal Library or one of the packaged application programs mentioned above to control your board. Only experienced programmers should try register-level programming.

If you need to program at the register level in your application, refer to the *Register Map for the CIO-DIO24, CIO-DIO24H, and CIO-DIO24/CTR3*. This document is available on our website at [www.mccdaq.com/registermaps/RegMapCIO-DIO24-Series.pdf](http://www.mccdaq.com/registermaps/RegMapCIO-DIO24-Series.pdf).



## Specifications

Typical for 25 °C unless otherwise specified.

Specifications in *italic text* are guaranteed by design.

### Digital Input / Output

Table 1. Digital input/output specifications

<i>Digital type</i>	82C55
<i>Configuration</i>	2 banks of 8, 2 banks of 4, programmable by bank as input or output
<i>Number of channels</i>	24 I/O
<i>Output high</i>	3.0 volts min @ -2.5 mA
<i>Output low</i>	0.4 volts max @ 2.5 mA
<i>Input high</i>	2.0 volts min, 5.5 volts absolute max
<i>Input low</i>	0.8 volts max, -0.5 volts absolute min
<i>Power-up / reset state</i>	Input mode (high impedance)
Interrupts	2 through 7, jumper selectable
Interrupt enable	External (IR Enable), logic low enabled (disabled by default via internal 10k resistor to +5V)
Interrupt sources	External (IR Input), rising edge
Miscellaneous	Locations provided for installation of pull-up or pull-down resistors.

### Power consumption

Table 2. Power consumption specifications

Parameter	Specification
+5V	170 mA typical, 270 mA max

### Environmental

Table 3. Environmental specifications

<i>Operating temperature range</i>	0 to 70 °C
<i>Storage temperature range</i>	-40 to +100 °C
<i>Humidity</i>	0 to 90% non-condensing

## Main connector and pin out

Table 4. Connector specifications

Connector type	37-pin male "D" connector
Compatible cables	C37FF-x C37-FFS-x DFCON-37 (D-connector, D-shell, and termination pins to construct your own cable)
Compatible accessory products with the C37FF-x cable and C37FFS-x cable	CIO-MINI37 CIO-SPADE50 SSR-RACK08 SSR-RACK24 CIO-ERB08 CIO-ERB24

Table 5. Connector pin out

Pin	Signal Name	Pin	Signal Name
1	IR Input	20	+5V
2	IR Enable	21	GND
3	FIRSPORTB Bit 7	22	FIRSPORTC Bit 7
4	FIRSPORTB Bit 6	23	FIRSPORTC Bit 6
5	FIRSPORTB Bit 5	24	FIRSPORTC Bit 5
6	FIRSPORTB Bit 4	25	FIRSPORTC Bit 4
7	FIRSPORTB Bit 3	26	FIRSPORTC Bit 3
8	FIRSPORTB Bit 2	27	FIRSPORTC Bit 2
9	FIRSPORTB Bit 1	28	FIRSPORTC Bit 1
10	FIRSPORTB Bit 0	29	FIRSPORTC Bit 0
11	GND	30	FIRSPORTA Bit 7
12	-5V	31	FIRSPORTA Bit 6
13	GND	32	FIRSPORTA Bit 5
14	-12V	33	FIRSPORTA Bit 4
15	GND	34	FIRSPORTA Bit 3
16	+12V	35	FIRSPORTA Bit 2
17	GND	36	FIRSPORTA Bit 1
18	+5V	37	FIRSPORTA Bit 0
19	GND		

# CE Declaration of Conformity

Manufacturer: Measurement Computing Corporation  
Address: 10 Commerce Way  
Suite 1008  
Norton, MA 02766  
USA

Category: Electrical equipment for measurement, control and laboratory use.

Measurement Computing Corporation declares under sole responsibility that the product

## **CIO-DIO24**

to which this declaration relates is in conformity with the relevant provisions of the following standards or other documents:

EU EMC Directive 89/336/EEC: Electromagnetic Compatibility, EN55022 (1987), EN50082-1

Emissions: Group 1, Class B

- EN55022 (1987): Radiated and Conducted emissions.

Immunity: EN50082-1

- IEC 801-2 (1987): Electrostatic Discharge immunity, Criteria B.
- IEC 801-3 (1984): Radiated Electromagnetic Field immunity Criteria A.
- IEC 801-4 (1988): Electric Fast Transient Burst immunity Criteria B.

Declaration of Conformity based on tests conducted by Chomerics Test Services, Woburn, MA 01801, USA in December, 1995. Test records are outlined in Chomerics Test Report #EMI0168B.95.

We hereby declare that the equipment specified conforms to the above Directives and Standards.



Carl Haapaoja, Director of Quality Assurance

**Measurement Computing Corporation**  
**10 Commerce Way**  
**Suite 1008**  
**Norton, Massachusetts 02766**  
**(508) 946-5100**  
**Fax: (508) 946-9500**  
**E-mail: [info@mccdaq.com](mailto:info@mccdaq.com)**  
**[www.mccdaq.com](http://www.mccdaq.com)**